

Gateway Board for BACnet and LonWorks

Supplemental Installation and Operation Manual

For use with RS, EL, DL, and
ME humidifiers with
Software version 5.9.x.x and 5.10.x.x

Thank you for choosing Condair

Installation date (MM/DD/YYYY):

Commissioning date (MM/DD/YYYY):

Site:

Model:

Serial number:

Contact

Condair Ltd.
2740 Fenton Road, Ottawa, Ontario K1T3T7
TEL: 1.866.667.8321, FAX: 613.822.7964
EMAIL: na.info@condair.com, WEBSITE: www.condair.com

Proprietary Notice

This document and the information disclosed herein are proprietary data of Condair Ltd. Neither this document, nor the information contained herein shall be reproduced, used, or disclosed to others without the written authorization of Condair Ltd., except to the extent required for installation or maintenance of recipient's equipment.

Liability Notice

Condair Ltd. does not accept any liability due to incorrect installation or operation of the equipment or due to the use of parts/components/equipment that are not authorized by Condair Ltd.

Copyright Notice

© Condair Ltd., All rights reserved.

Technical modifications reserved

Contents

1	Introduction	4
1.1	Notes on this addendum manual	4
1.2	Functions overview	5
2	For your safety	6
3	Network integration via the optional LonWorks and BACnet Gateway boards	8
3.1	Notes for the planning engineer	8
3.1.1	Overview	8
3.1.2	Principle Network diagrams	9
3.1.2.1	Principle BACnet network	9
3.1.2.2	Principle LonWorks network	11
3.2	Installation work	12
3.2.1	Installing the BACnet/LonWorks gateway board on the Integrated Controller	12
3.2.2	Wiring	13
3.3	Configuration	14
3.3.1	Configuring the Condair Integrated Controller	14
3.3.1.1	Setup control settings	14
3.3.1.2	Monitoring of bus communication	15
3.3.1.3	BMS Timeout and Modbus settings	16
3.3.2	Gateway configuration	17
3.3.2.1	Requirements for gateway configuration	17
3.3.2.2	Configure the IP settings	18
3.3.2.3	Modifying the BACnet configuration	23
3.4	Communication tables	26
3.4.1	DL - BACnet (Integrated Controller software version 5.9.x.x)	26
3.4.2	DL - LonWorks (Integrated Controller software version 5.9.x.x)	29
3.4.3	ME - BACnet (Integrated Controller software version 5.9.x.x and 5.10.x.x)	32
3.4.4	ME- LonWorks (Integrated Controller software version 5.9.x.x and 5.10.x.x)	35
3.4.5	RS - BACnet (Integrated Controller software version 5.9.x.x)	38
3.4.6	RS - LonWorks (Integrated Controller software version 5.9.x.x)	42
3.5	Troubleshooting	46
3.5.1	Operating trouble list	46
3.5.2	LED functions	48
4	Appendix	51
4.1	Object abbreviations	51
5	Ordering form	52

1 Introduction

1.1 Notes on this addendum manual

Condair devices equipped with an Integrated Controller can either be connected via the corresponding interface on the Integrated Controller (BACnet on-board) to a BACnet IP network or a BACnet MS/TP network or via the optional LonWorks or BACnet gateway boards (ProtoCessor gateway) to a LonWorks, BACnet IP or BACnet MS/TP network to a building management system.

This manual describes how to install and configure the optional LonWorks and BACnet gateway boards (see [chapter 3](#)) to connect the corresponding Condair devices to a building management system.

This addendum manual is intended for use by engineers and properly trained technical personnel. Please read this manual thoroughly before installing and configuring the BACnet or LonWorks based network.

If you have questions after reading this documentation, please contact your Condair representative. They will be glad to assist you.

Symbols used in this manual

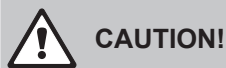

The catchword "CAUTION" used in conjunction with the caution symbol in the circle designates notes in this manual that, if neglected, may cause **damage and/or malfunction of the unit or other material assets**.



The catchword "WARNING" used in conjunction with the general caution symbol designates safety and danger notes in this manual that, if neglected, may cause **injury to persons**.



The catchword "DANGER" used in conjunction with the general caution symbol designates safety and danger notes in this manual that, if neglected, may lead to **severe injury or even death of persons**.

Safekeeping

Please safeguard this addendum manual in a safe place, where it can be immediately accessed. If the equipment changes hands, the documentation must be passed on to the new operator.

If the documentation gets mislaid, please contact your Condair representative for replacement.

Language versions

This addendum manual is available in various languages. Please contact your Condair representative for information.

1.2 Functions overview

The following table gives you an overview of the supported protocols and functions.

	Optional BACnet Gateway board	Optional LonWorks Gateway board
BACnet IP and BACnet MS/TP BTL certified	yes	no
BACnet IP	yes	no
BACnet MS/TP Master Mode	yes	no
BACnet MS/TP Slave Mode	yes	no
LonWorks certified	no	yes
Remote"RS draining"	yes	yes
BACnet Service COV (Change of Value)	yes	no

Please refer to the objects tables for detailed information.

2 For your safety

General

Every person working with the Condair Integrated Controller must have read and understood this addendum manual, and the installation manual and operation manual of the Condair Integrated Controller, before carrying out any work.

Knowing and understanding the contents of the manuals is a basic requirement for protecting the personnel against any kind of danger, to prevent faulty operation, and to operate the unit safely and correctly.

All icons, signs and markings applied to the unit must be observed and kept in readable state.

Qualification of personnel

All work described in this addendum manual **may only be carried out by specialists who are well trained and adequately qualified and are authorised by the customer.**

For safety and warranty reasons any action beyond the scope of this manual must be carried out only by qualified personnel authorised by the manufacturer.

It is assumed that all persons working with the Condair Integrated Controller are familiar and comply with the appropriate local regulations on work safety and the prevention of accidents.

Intended use

The optional LonWorks or BACnet gateway boards are intended exclusively for connecting the Condair Integrated Controller to a LonWorks or BACnet based network. Any other type of application, without the written consent of the manufacturer, is considered as not conforming with the intended purpose and may lead to the Condair Integrated Controller becoming dangerous.

Operation of the equipment in the intended manner requires **that all the information contained in this addendum manual as well as in the installation manual and operation manual of the Condair Integrated Controller are observed.**

Danger that may arise from the Condair Integrated Controller

 **DANGER!**
Risk of electric shock!

The electrical compartment where the Integrated Controller is located may have live mains voltage connected for other uses of the device. Live parts may be exposed when the control unit is open. Touching live parts may cause severe injury or danger to life.

Prevention: Before commencing any work on the control unit disconnect the mains supply voltage to the humidifier via the electrical isolator in the mains supply line, and secure electrical isolator in "Off" position against inadvertent switching on.

Safety reporting

All persons working with the Condair Integrated Controller are obliged to report any alterations to the system that may affect safety to the owner without delay and to **secure such systems against accidental power-up**.

Prohibited modifications to the unit

No modifications must be undertaken on the optional LonWorks or BACnet gateway boards and on the Condair Integrated Controller without the express written consent of the manufacturer.

For the replacement of defective components use exclusively **original accessories and spare parts** available from your Condair representative.

3 Network integration via the optional LonWorks and BACnet Gateway boards

3.1 Notes for the planning engineer

3.1.1 Overview

The optional LonWorks or BACnet gateway boards allow the integration of the Condair Integrated Controller into a **BACnet IP**, **BACnet MS/TP** or a **LonWorks** network. The optional LonWorks or BACnet gateway boards feature a serial-interface gateway which converts the information from the host RTU Modbus protocol to a specified secondary protocol.

Important: Please note that the gateway board is configured for the latest software version of the Integrated Controller. To guarantee correct data communication it is therefore mandatory to update the software of the Integrated Controller to the latest version before installing the gateway board. Please contact your Condair distributor regarding a software update of the Integrated Controller.

The following protocol options are available and must be specified when ordering:

Part Number	Protocols	Part Description
2583810	BACnet IP	BMS Set Master BACnet IP ME
2583813	BACnet MS/TP	BMS Set Master BACnet MS/TP ME
2583808	LonWorks	BMS Set Master LonWorks ME
2583809	BACnet IP	BMS Set Master BACnet IP RS
2583812	BACnet MS/TP	BMS Set Master BACnet MS/TP RS
2583807	LonWorks	BMS Set Master LonWorks RS
2582291	BACnet IP	BMS Set Master BACnet IP DL
2583811	BACnet MS/TP	BMS Set Master BACnet MS/TP DL
2582290	LonWorks	BMS Set Master LonWorks DL
2586239	BACnet IP	BMS Set Master BACnet IP EL
2586240	BACnet MS/TP	BMS Set Master BACnet MS/TP EL
2587508	LonWorks	BMS Set Master LonWorks EL

Please refer to the BACnet object or Lonworks SNVT tables in [chapter 3.4](#) for detailed information regarding the available read out and settings functions.

3.1.2 Principle Network diagrams

3.1.2.1 Principle BACnet network

The principle diagram below shows the connection of the Condair Integrated Controller to an Ethernet network.

Principle BACnet IP network



Abb. 1: Principle BACnet IP network

Principle BACnet MS/TP network

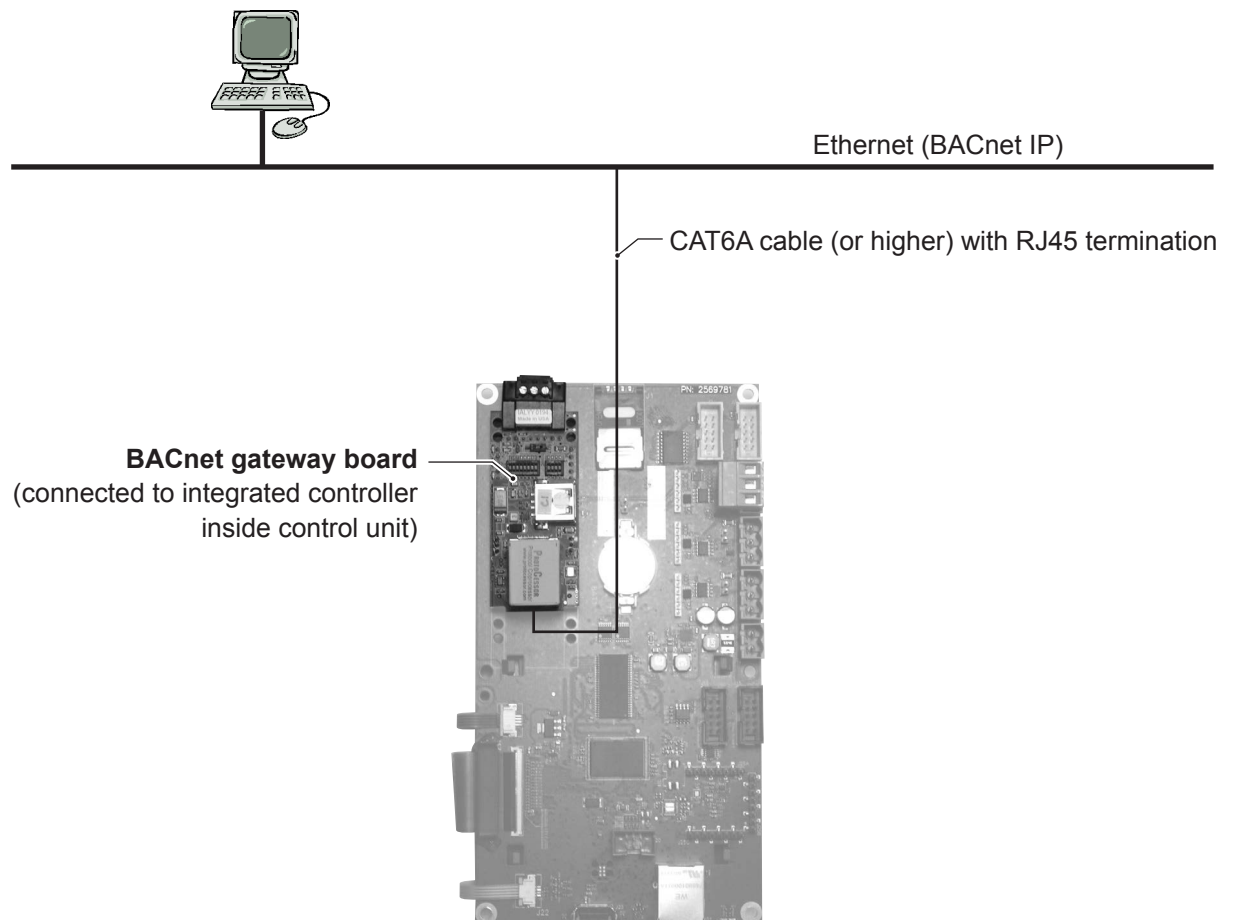

Abb. 2: Principle BACnet MS/TP network

3.1.2.2 Principle LonWorks network

This principle diagram below shows the connection of the Condair Integrated Controller to a LonWorks network via a shielded twisted-pair cable.

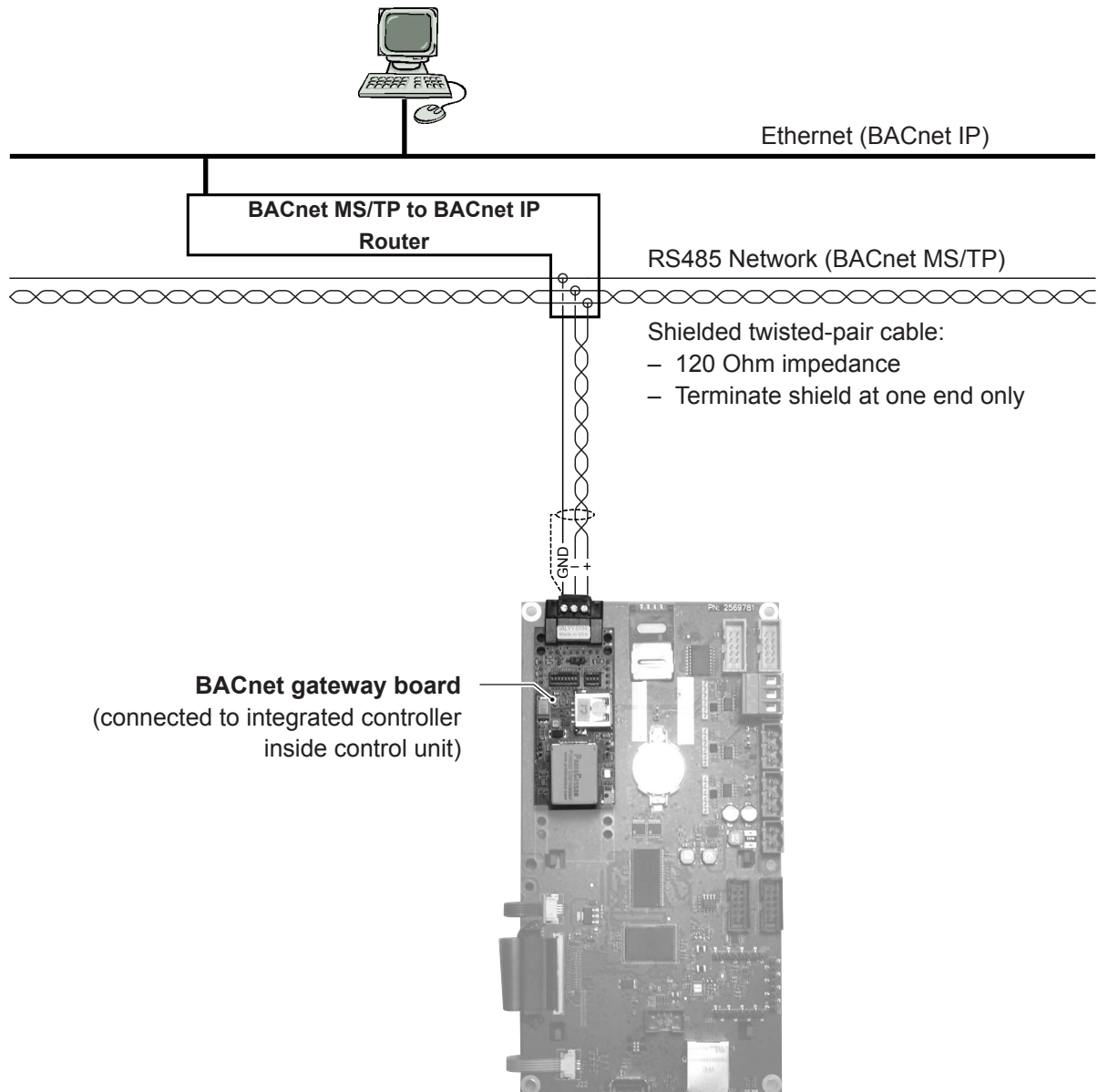

Abb. 3: Principle LonWorks network

3.2 Installation work

3.2.1 Installing the BACnet/LonWorks gateway board on the Integrated Controller

1. Isolate power supply to the controller unit.
2. Remove the front cover of the control unit.

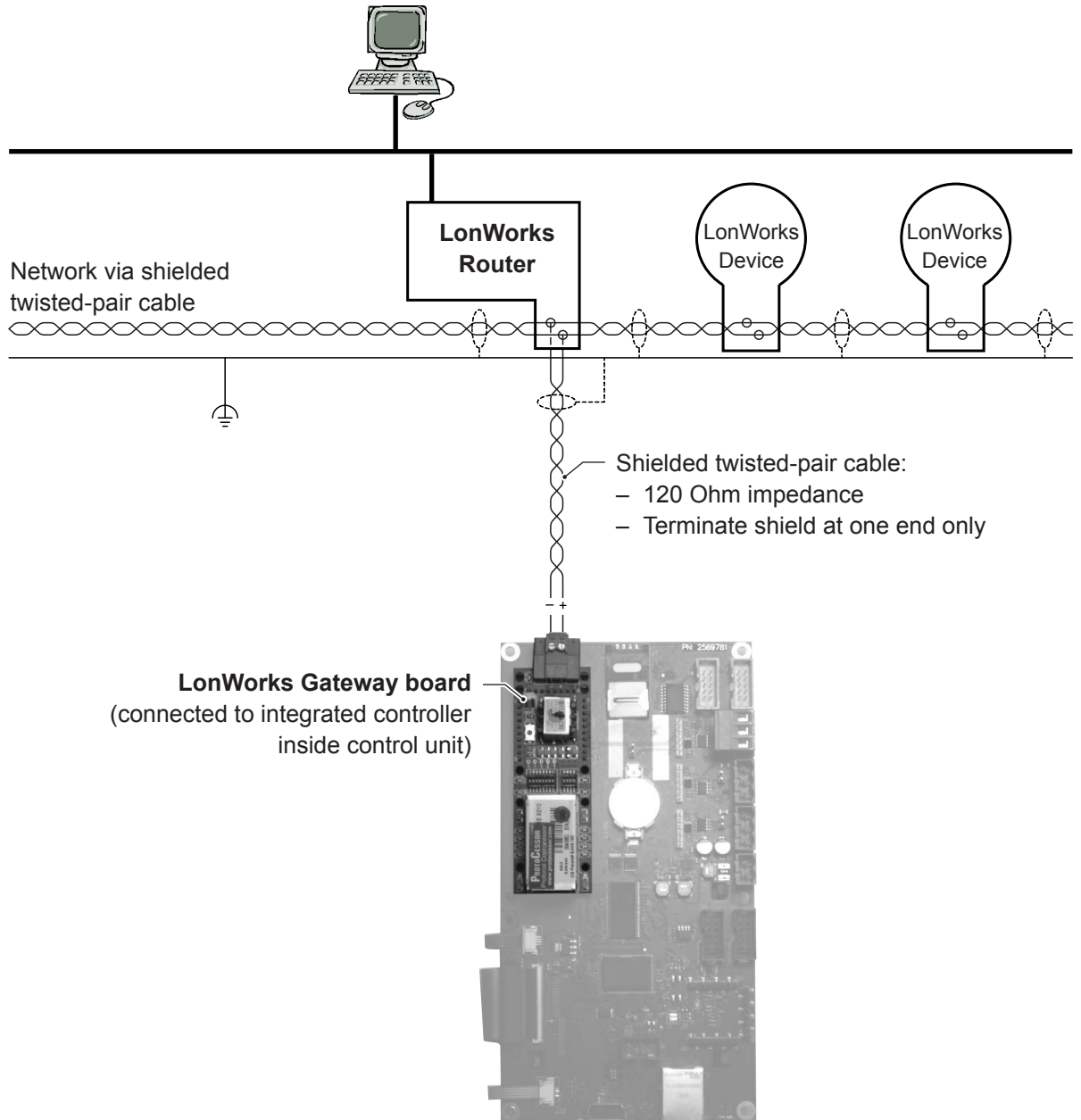

CAUTION!

Electronic components are very sensitive to electrostatic discharge. Before proceeding with the next step, appropriate measures (ESD-protection) must be taken to prevent damage to electronic components. A wrist strap should be worn to connect the maintenance specialist with a common ground point. For more information, refer to ANSI/ESD-S20.20.

3. Open the control unit inner door.
4. Fix BACnet or LonWorks gateway board to the TTL interface on the Condair Integrated Controller. **Important:** Ensure pin alignment when fixing.
5. Remove Jumper "J7".



Abb. 4: Installing the BACnet/LonWorks gateway board on the integrated controller (ME control module shown).

3.2.2 Wiring

1. Lead the network cable through the rectangular cable lead-through into the control unit. Inside the control unit run the cable to the BACnet or LonWorks gateway board, respectively.
2. Connect network cable according to the following wiring diagrams.

BACnet

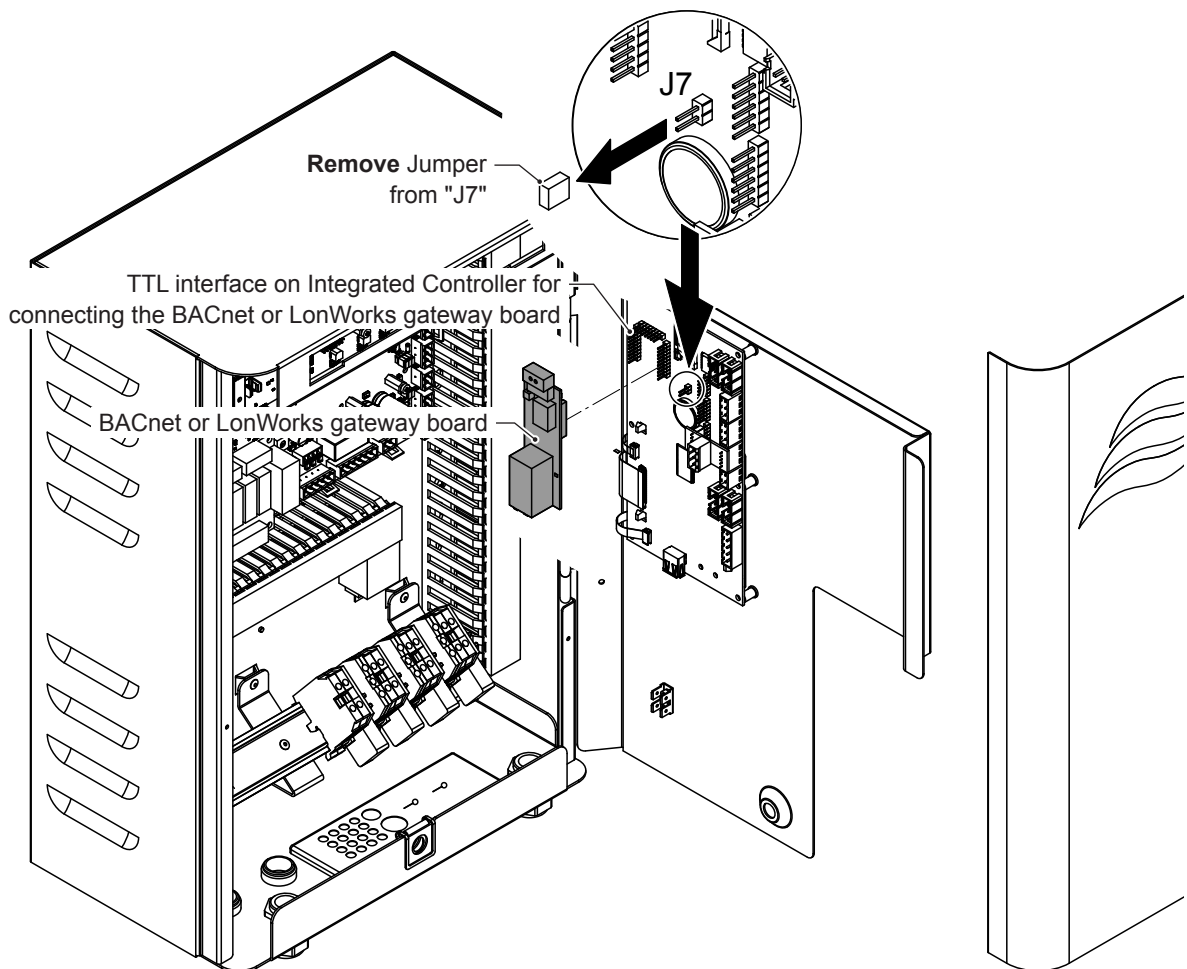

Abb. 5: BACnet IP network connection

To network via shielded twisted-pair cable:

- 120 Ohm impedance
- Terminate shield at one end only

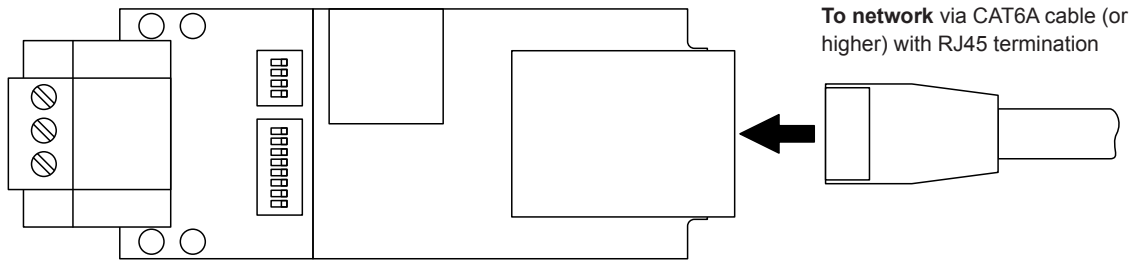

Abb. 6: BACnet MS/TP network connection

LonWorks

To network via shielded twisted-pair cable:

- 120 Ohm impedance
- Terminate shield at one end only

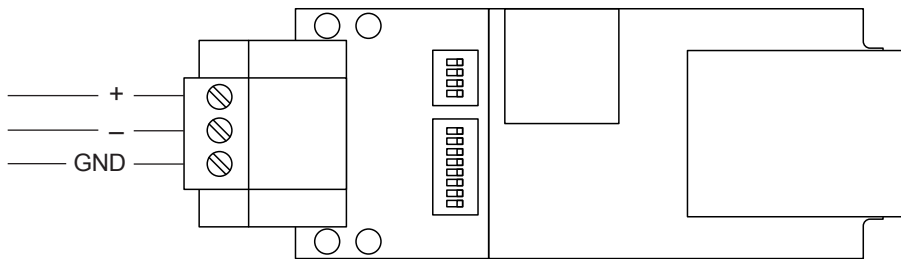

Abb. 7: LonWorks network connection

3.3 Configuration

After wiring connections have been completed, the Condair Integrated Controller needs to be setup to operate and communicate through its optional BACnet or LonWorks gateway board. This setup includes the settings in the "Control Settings" and the "Communication" submenu of the Condair Integrated Controller unit and the **Gateway configuration**.

3.3.1 Configuring the Condair Integrated Controller

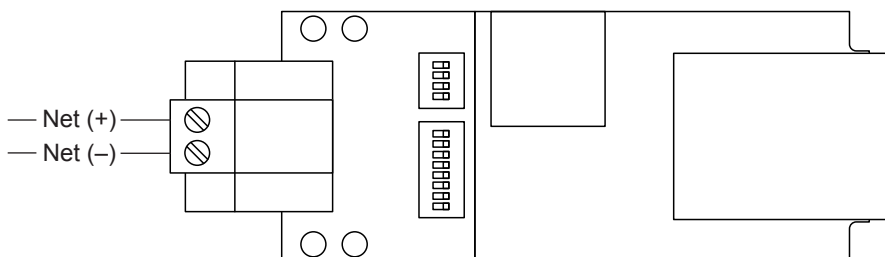
3.3.1.1 Setup control settings

By default the Condair Integrated Controller is configured to operate on a hardwired analog control signal from an external humidity controller or a humidity sensor (if internal P or PI controller is used) connected to the driver board inside the control unit.

Note: If you want the Condair Integrated Controller to be controlled via a hardwired analog control signal set "Signal Source" to "Analog" and set the other control settings as required (see "Operation Manual" of the corresponding device for details).

If you want to control the Condair Integrated Controller entirely via the network through the optional BACnet or LonWorks gateway board the "Control Settings" must be adjusted as follows:

1. Close control unit and switch it on.
2. Select "Control Settings" submenu as shown below.



3. Set **control settings** as follows (see rightmost screen):

Signal Source:	Modbus
System Mode:	Humidifying or Cooling (only by ME)
Control Mode:	Demand (if you use a external demand control signal) RH P (if you use a sensor signal and proportional controller) RH PI (use a sensor value and proportional-integral controller)

Note: see Humidifier Operation Manual for details on control settings.

3.3.1.2 Monitoring of bus communication

The monitoring of the bus communication described below only takes place if the "Source" parameter in the "Control Settings" menu is not set to "Analog".

As soon as the signal is transmitted via a BACnet or LonWorks gateway board, communication via the bus system is also monitored. The control signal must be periodically updated within the time set in "BMS Timeout".

If the control signal is not updated within the set time, warning "W35 - BMS Timeout" will be triggered and the humidification will be stopped until a valid signal is returned.

This monitoring is intended to prevent the humidifier from humidifying with the last transmitted value in the event of a bus failure.

Note: The gateway board transfers the control signal to the humidifier only if the value changes!

3.3.1.3 BMS Timeout and Modbus settings

To allow the Condair Integrated Controller to be controlled via the BMS through the optional BACnet or LonWorks gateway board the Condair Integrated Controller must be configured as follows:

1. Switch on control unit (if not already switched on).
2. Select "Communication" submenu as shown below.

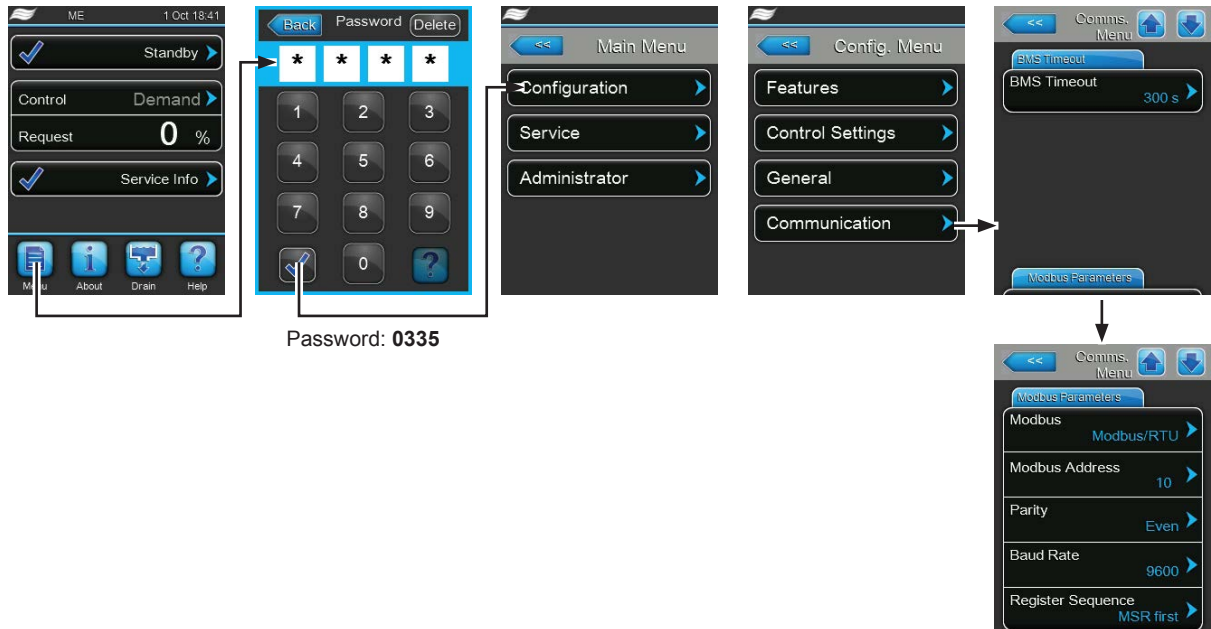

3. Select "**BMS Timeout**" tab and set **BMS Timeout** to the desired values:

Factory setting: **300 s**
Setting range: **1 - 300 s**

4. Select "**Modbus Parameter**" tab and set **Modbus settings** as follows (see rightmost screen):

Modbus: **Modbus/RTU**
Modbus Address: **10**
Parity: **Even**
Baud Rate: **9600**
Register Sequence: **MSR first**

Important! Please note that the gateway board is communicating with the Integrated Controller of the device via the Modbus RTU protocol. When using a gateway board the "**BACnet**" function in the "**Configuration > Communication**" submenu must be deactivated!

3.3.2 Gateway configuration

The **protocol configuration is made at the factory**, prior to final testing. The following values are set ex factory (adjustable values see [chapter 3.3.2.2](#) and [chapter 3.3.2.3](#)):

BACnet

Protocol	Baud rate	BACnet MS/TP MAC Address	Node ID	Parity
BACnet IP	10 / 100 BaseT	---	DL: 300 RS: 710 ME: 410 EL: 220	---
BACnet MS/TP Master	9600 Baud	127	1001	None

LonWorks

Protocol	Baud rate	Lonmark Objects		
LonWorks	78125 bps	#0 Node	#520 Analog Input *	#521 Analog Output

* The Condair RS consists of two analog input objects (Unit A and unit B). The second analog input object holds only the SNVT's of unit B.

3.3.2.1 Requirements for gateway configuration

Hardware Requirements

A PC with web browser that connects over Ethernet on port 80 and a Ethernet cable to establish the connection between Computer/Laptop and BACnet or LonWorks gateway board.

PC Software Requirements

One of the following web browsers must be used:

- Mozilla Firefox 13.0 and up
- Microsoft Internet Explorer 8 and up
- Google Chrome 19.0 and up
- Opera 11 and up
- Microsoft Edge

Please note that the computer and network firewalls must be opened for Port 80 to allow FS-GUI to function.

3.3.2.2 Configure the IP settings

For BACnet and LonWorks application, an IP address and the subnet mask must be assigned to the BACnet/LonWorks gateway board in order to access it. The IP address and subnet mask may be assigned at the factory or can be modified at any time via the integrated FS-GUI (Fieldserver Graphic User Interface) of the gateway board.

Ex factory the gateway board is configured to the following default settings:

	Until the end of January 2022	From February 2022
IP address	10.232.72.172	192.168.1.24
Subnet mask	255.255.0.0	255.255.255.0
Default gateway	10.232.72.1	192.168.1.1

To configure a new IP address, subnet mask and default gateway via the integrated FS-GUI of the gateway board proceed as follows:

1. Connect the gateway board **to a PC using an Ethernet cross-over cable** or **directly to the network using a straight cable**.
2. Make sure your PC is in the same IP network as the gateway board (default IP settings see table above); otherwise assign a static IP address to your PC.
3. Switch on Condair Integrated Controller unit in order to power up the gateway board.
4. Open your internet browser and enter the IP address of the gateway board (according table above), then confirm the entry with the Enter key.

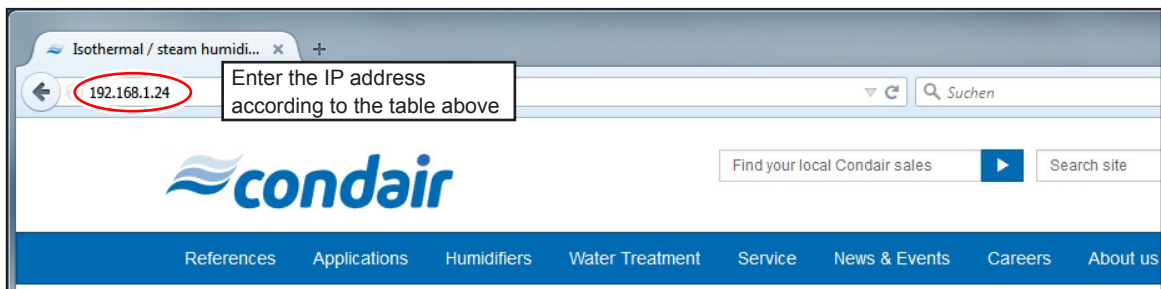

5. Depending on the FS-GUI version either the start screen or the login screen appears:
 - If the start screen appears: Press the <Diagnostics & Debugging> button at the bottom right of the screen.
 - If the login screen appears: Enter "admin" as the username and the password (can be found on the sticker of the gateway board). Then confirm your entries with the <Log In> button.
 Note: The password should later be changed under "Setup > User Management / Password" (see step 6).

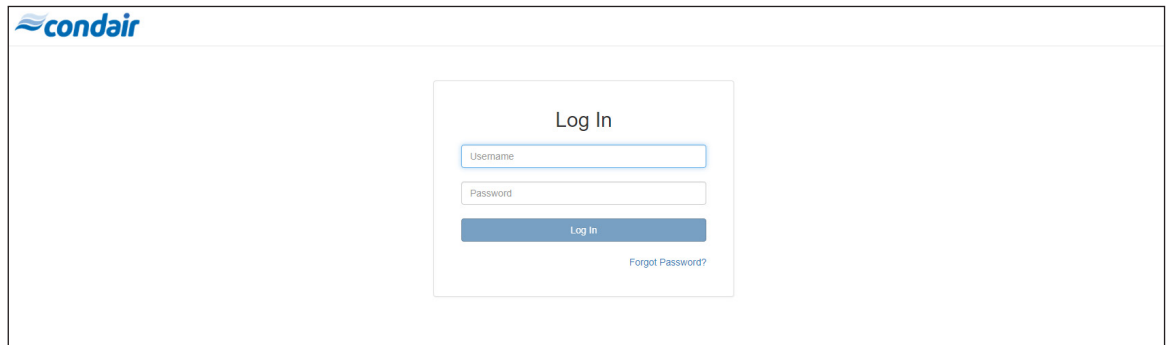

Note: After 5 unsuccessful attempts to enter the password, access will be blocked for 10 minutes!

The FS-GUI will be started.

The screenshot displays the 'BMS DL II BACnet IP' status page. The table below shows the system's configuration and resource usage.

Name	Value
Driver_Configuration	DCC000
DCC_Version	V6.05p (A)
Kernel_Version	V6.51c (D)
Release_Status	Normal
Build_Revision	6.1.3
Build_Date	2021-09-08 13:12:43 +0200
BIOS_Version	4.1.2
FieldServer_Model	FPC-N34
Serial_Number	21260_1001PXX
Carrier_Type	SPR Carrier
Data_Points_Used	19
Data_Points_Max	1500
Application Memory:	
Protocol_Engine_Memory_Used	0.81%
Memory_Used	1,223 kB
Memory_Available	150,555 kB
Memory_Free_Bytes	150,555 kB
Memory_Min_Free_Bytes	150,213 kB
Memory_Max_Percent_Used	0.81%
Memory_Max_Bytes_Used	1,223 kB
Memory_Blocks	5155
Avg_Cycle_Time	2
Min_Cycle_Time	1
Max_Cycle_Time	68
Cache_Usage_(RDB)	0

The footer of the GUI contains several buttons: Home, HELP (?), Contact Us, System Restart, System Reboot, System Time Synch, Reset Cycle Times, and Logout. The 'fieldserver' logo is visible in the bottom right corner.

6. Select the menu point "**Setup > User Management / Password**" in the "**Navigation Tree**". Enter the new password and confirm it with the <Confirm> button.



CAUTION!

Remember the new password. The password on the sticker of the gateway board is no longer valid after the alteration.

7. Select the menu point "**Setup > Security**" in the "**Navigation Tree**" in order to select the security mode the FS-GUI should use.



CAUTION!

The gateway board is factory configured for HTTP protocol. It is strongly recommended to change this setting to an HTTPS protocol (HTTPS = encrypted, secure connection)!

Select the desired protocol type and then press <Save>.

8. Select the menu point "**Setup > User Management**" in the "**Navigation Tree**" in order to define the users having access to the FS-GUI.

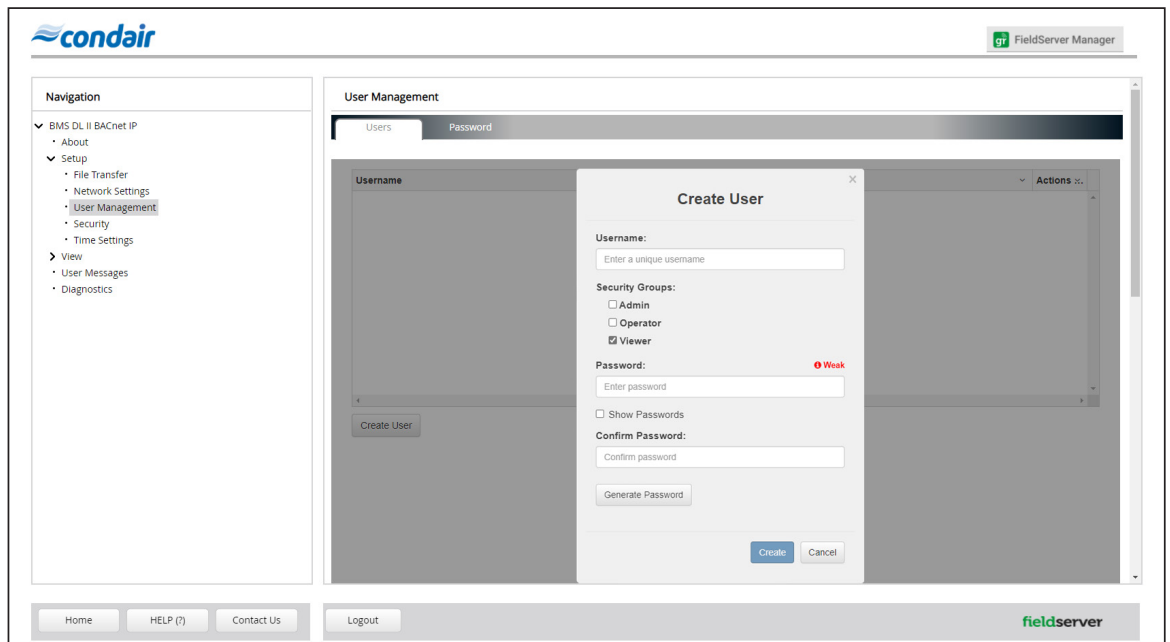

- Press the <Create User> button.
- Enter a "Username".
- Select the security group under "Security Groups":
 - Admin: Can modify and view any settings on the FS-GUI
 - Operator: Can modify and view specific data in the array(s).
 - Viewer: Can only view settings/readings on the FS-GUI
- Enter a password in the "Password" field and confirm it in the "Confirm Password" field.
- Confirm the entries with <Create>.

9. Select the menu point "**Setup > Network Settings**" in the "**Navigation Tree**". Enter the appropriate **IP Address**, **Netmask** (Subnetmask), **Gateway** (Default Gateway) **Domain Name Server 1** (optional) and **Domain Name Server 2** (optional).

If you would like the "IP Address", "Netmask", "Gateway", "Domain Name Server 1" and "Domain Name Server 2" to be assigned via a DHCP server, activate the "Enable DHCP" ¹⁾ mode.

¹⁾ Depending on the date of manufacture, also called "DHCP Client State".

To activate the new settings, click first on the button **<Update IP settings>** and then on the button **<System Restart>**. After restart the gateway board is configured to the new settings.

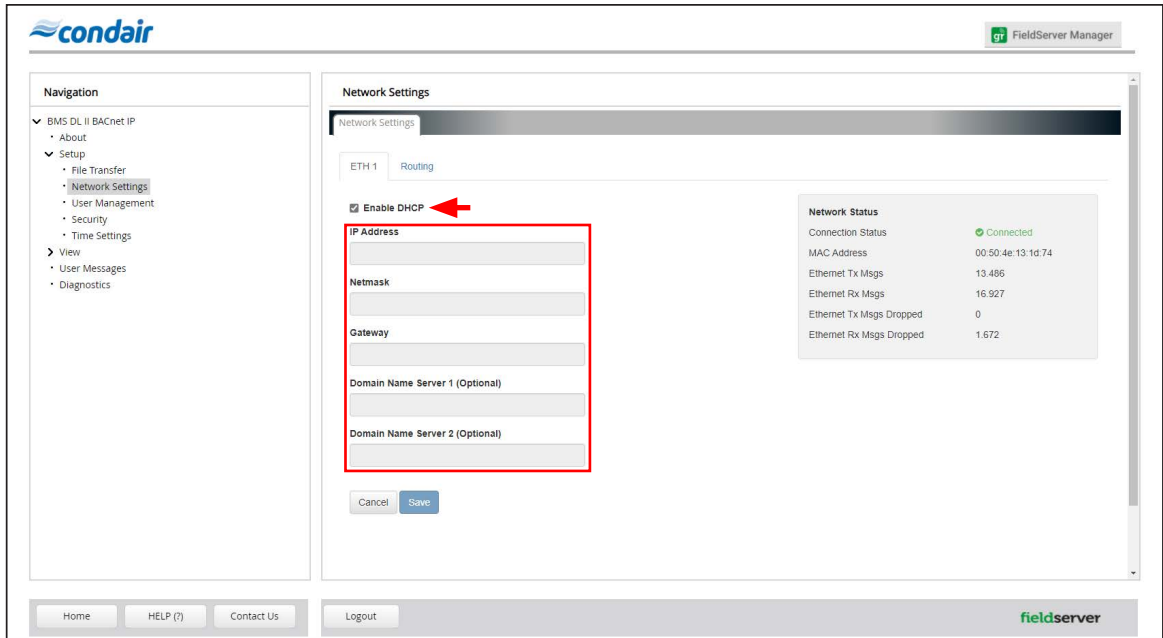

10. In order to access the gateway board, the IP address of your laptop must be set to the same network as the gateway board.

3.3.2.3 Modifying the BACnet configuration

1. Enter the (new) IP address of the gateway board in your internet browser and confirm the entry with the Enter key. The FS-GUI will be started.
2. Select the menu point "**Setup > File Transfer**" in the "**Navigation Tree**". Then, click in the "**Retrieve**" section on the link "**config.csv**" and save the configuration file to the desired location on your laptop.

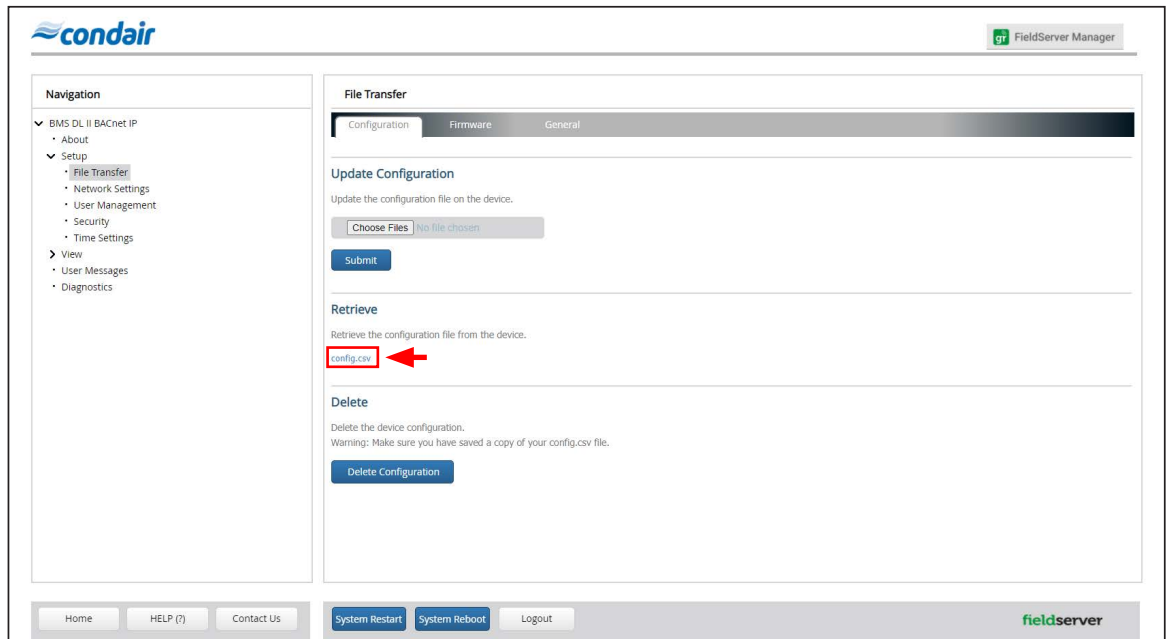

BACnet IP settings:

3a. Open the configuration file "config.csv" with a text editor.

- Change in the section "**Server Side Nodes**" of the window the "Node_ID" to the appropriate value. Range: 0...4194303

```
//=====
//  Server Side Nodes
Nodes
Node_Name,Node_ID,Protocol,Node_Offline_Response,Description
Virtual_BCU_DL,300,Bacnet_IP,Force_Normal_Response,Humidifier DL
//=====
```

- Change in the section "**Bridge**" of the window the "**Network_Number**" to the appropriate value. Default Network_Number: 101, Range: 1 - 65534.

```
//=====
//  Common Information
Bridge
Title,System_Node_Id,Network_Number
BMS DL BACnet_IP_5x,12,101
//=====
```

- Save the configuration file after all settings have been done.

BACnet MS/TP settings:

3b. Open the configuration file "config.csv" with a text editor.

- Change in the section "**Bridge**" of the window the "**System_Station_Address**" (= MAC address) to the appropriate value. Default MAC address: 127, Range: 1...127 (Master) or 1...254 (Slave).

```
Bridge
Title,System_Station_Address
BMS DL BACnet_MSTP_5x,127
//=====================================================
```

- Change in the section "**Server Side Nodes**" of the window the "**Node_ID**" to the appropriate value. Default Node_ID: 1001, Range: 1...16777215

```
//=====
// Server Side Nodes
Nodes
Node_Name,Node_ID,Protocol,Description
Virtual_BCU_DL,1001,Bacnet_MSTP,Humidifier DL
//=====================================================
```

- Change a Master unit to a Slave unit: Change in the section "**Server Side Connections**" of the window the "**MSTP_Master_Mode**" to "**MSTP_Slave_Mode**". If a Master unit is changed to a Slave unit the "**System_Station_Address**" must be adjusted to a value between 1 and 254 (see first step in this section).

```
//=====
// Server Side Connections
Connections
Port,Baud,Parity,Data_Bits,Stop_Bits,Protocol,Connection_Type
R1,9600,None,8,1,Bacnet_MSTP,MSTP_Master_Mode
//=====================================================
```

- Save the configuration file after all settings have been done.

Upload config.csv file:

4. Select the menu point "**Setup > File Transfer**" in the "**Navigation Tree**". Click in the "**Update**" section on the button **<Choose Files>** and select the configuration file you have modified. Then, click on the button **<Submit>** in order to upload the configuration file into the gateway board.

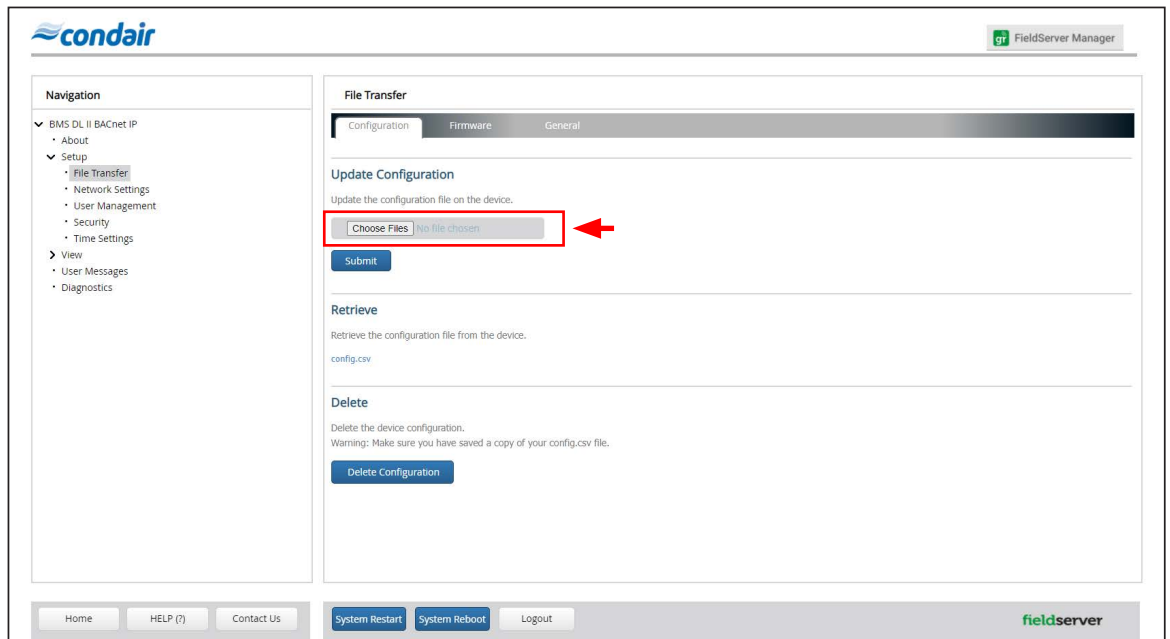

As soon as the update is finished a corresponding message appears in the upper part of the window. Click on the button **<System Restart>** to restart the system with the new settings. After restart the Node ID or MAC address is changed to the new value.

Important: If the red LED on the gateway board lights for more than 15 seconds after the update of the configuration file, a false input was done during adjustment of the configuration file! The appropriate error message can be viewed in the "**Navigation Tree**" of FS-GUI under "**User Messages > Errors**".

Note: The message "No Messages" indicates an error-free configuration file.

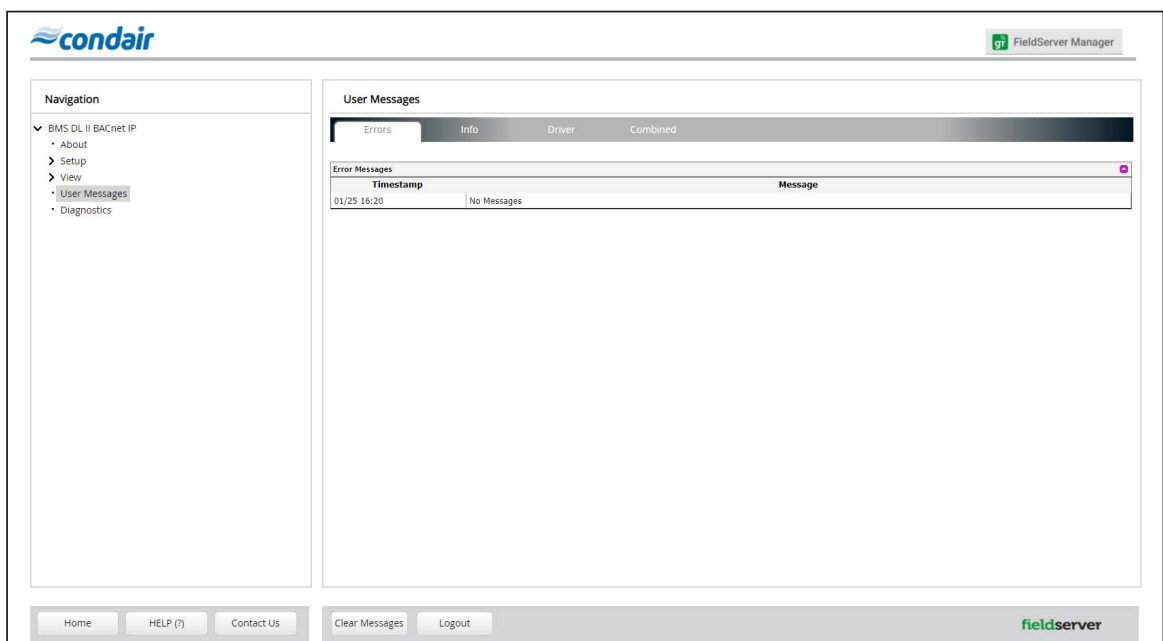

3.4 Communication tables

The following table shows the gateway variables and their BACnet / LonWorks equivalents.

3.4.1 DL - BACnet (Integrated Controller software version 5.9.x.x)

Object Name	Description	Range	Object-Type	Object-ID	Read (R) Write (W)
Virtual_BCU_DL	Humidifier DL	—	DEV	300 (see chapter 3.3.2)	—
MI_HumStatus	Operating status	1 = Initializing 2 = Diagnostic 3 = Stopped 4 = Flushing 5 = Standby 6 = Flushed 7 = Humidifying 8 = Ready 9 = Refreshing 10 = Air Pressure Cleaning 11 = Filling 12 = Conductivity Flush 13 = Switched Off 14 = Remote Off 15 = Regenerating 16 = Temperature Flush 17 = Ceramic Wash Over	MI	01	R
MI_ServStatus	Maintenance and malfunctions status	1 = Service Info 2 = Warning 3 = Activation Code 4 = Out of Commissioning 5 = Refill Disinfection 6 = Service 7 = Fault 8 = Replace Ag Cartridge 9 = Disinfection	MI	02	R
MI_HumType	Device type	1 = Hum 2 = Hum + FC 3 = Hum + RO-C 4 = Hum + FC-off	MI	03	R
AI_ErrorCode	Error code ²⁾	0 = no Error	AI	01	R
AI_OperatHours	Operating hours	0 - 1'200'000 h	AI	02	R
AI_HoursToServ	Next service	0 - 10000 h	AI	03	R
AI_RHorDemand	Actual humidity or demand	0 - 100 %	AI	04	R
AI_MaxHumOut	Max. capacity ¹⁾	2 - 1000 kg/h 4 - 2573 lb/hr	AI	05	R
AI_ActCapHum	Actual capacity ¹⁾	0 - 1000 kg/h 0 - 2573 lb/hr	AI	06	R
AI_RemCapSilv	Remaining Ag-Ion capacity	0 - 58.4 Ah	AI	07	R
AI-TaAgCurrent	Target Ag-Ion current	0 - 29.2 mA	AI	08	R
AI_PressInlet	Inlet pressure PS4 ¹⁾	0 - 12.0 bar 0 - 174.0 psi	AI	09	R
AI_PressNozzle	Nozzle pressure PS5 ¹⁾	0 - 12.0 bar 0 - 174.0 psi	AI	10	R
AI_ActPermTemp	Water temperature ¹⁾	°C or °F	AI	11	R

Object Name	Description	Range	Object-Type	Object-ID	Read (R) Write (W)
AI_ActPermCond	Conductivity	µS/cm	AI	12	R
AI_PumpCurrent	Pump current	0 - 5.0 A	AI	13	R
AI_AgCurrent	Ag-Ion current	mA	AI	14	R

¹⁾ According to the settings <Imperial> or <Metric> in the DL controller software.

²⁾ See Error code description in the malfunction list in the DL operation manual.

Object Name	Description	Range	Object-Type	Object-ID	Read (R) Write (W)
AV_SetPointHum	Humidity setpoint	0 - 95 %	AV	01	R/W
AV_PropBand	Proportional band	6 - 65 %	AV	02	R/W
AV_IntTime	Integral time	1 - 60 min	AV	03	R/W
AV_CapLimit	Manual capacity	20 - 100 %	AV	04	R/W
AV_RemoteFlush	Remote flush	Read: 0 = Off 2 = Flushing active Write: 0 = Stop flushing 1 = Start flushing	AV	05	R/W
AV_CeramicWashOver	Ceramic wash over	Read: 0 = Off 2 = Ceramic wash over active Write: 0 = Stop ceramic wash over 1 = Start ceramic wash over	AV	06	R/W
AO_RemRHorDem	Actual humidity or demand via BACnet	0 - 100 % Relinquish Default = 0	AO	01	R/W

Object Name	Description	Range	Object-Type	Object-ID	Read (R) Write (W)
BI_ExtSchSta	Safety loop	0 = Open 1 = Closed (ok)	BI	01	R
BI_ValveY1	Y1 inlet valve	0 = Closed 1 = Open	BI	02	R
BI_ValveY2	Y2 valve		BI	03	R
BI_ValveY3	Y3 valve air cleaning	0 = Closed 1 = Open	BI	04	R
BI_ValveY4	Y4 valve external pipe flush	0 = Closed 1 = Open	BI	05	R
BI_StageValveY5	Y5 valve spray circuit	0 = Closed 1 = Open	BI	06	R
BI_StageValveY6	Y6 valve spray circuit	0 = Closed 1 = Open	BI	07	R
BI_StageValveY7	Y7 valve spray circuit	0 = Closed 1 = Open	BI	08	R
BI_StageValveY8	Y8 valve spray circuit	0 = Closed 1 = Open	BI	09	R
BI_StageValveY9	Y9 valve spray circuit	0 = Closed 1 = Open	BI	10	R
BI_DrainValY10	Y10 valve drain (NO)	0 = Open 1 = Closed	BI	11	R
BI_ValveY11	Y11 auxiliary outlet valve	0 = Open 1 = Closed	BI	12	R
BI_Pump	FC enable	0 = Disable 1 = Enable	BI	13	R
BI_Connection	Node status	0 = Node offline 1 = Node online	BI	14	R

3.4.2 DL - LonWorks (Integrated Controller software version 5.9.x.x)

Variable Name	Description	Range	SNVT	#SNVT	Index
nviRequest	Requesting the status		SNVT_obj_request	92	0
nvoStatus	Current status		SNVT_obj_status	93	1
nvoHumStatus	Operating status	0 = Initializing 1 = Diagnostic 2 = Stopped 3 = Flushing 4 = Standby 5 = Flushed 6 = Humidifying 7 = Ready 8 = Refreshing 9 = Air Pressure Cleaning 10 = Filling 11 = Conductivity Flush 12 = Switched Off 13 = Remote Off 14 = Regenerating 15 = Temperature Flush 16 = Ceramic Wash Over	SNVT_count	8	2
nvoServStatus	Maintenance and malfunctions status	0 = Service Info 1 = Warning 2 = Activation Code 3 = Out of Commissioning 4 = Refill Disinfection 5 = Service 6 = Fault 7 = Replace Ag Cartridge 8 = Disinfection	SNVT_count	8	3
nvoHumType	Device type	0 = Hum 1 = Hum + FC 2 = Hum + RO-C 3 = Hum + FC-off	SNVT_count	8	4
nvoErrorCode	Error code ²⁾	0 = no Error	SNVT_count	8	5
nvoOperatHours	Operating hours	0 - 65535 h	SNVT_time_hour	124	6
nvoHoursToServ	Next service	0 - 10000 h	SNVT_time_hour	124	7
nvoRHorDemand	Actual humidity or demand	0 - 100 %	SNVT_lev_percent	81	8
nvoMaxHumOut	Max. capacity ¹⁾	2 - 1000 kg/h 4 - 2573 lb/hr	SNVT_count_f	51	9
nvoActCapHum	Actual capacity ¹⁾	0 - 1000 kg/h 0 - 2573 lb/hr	SNVT_count_f	51	10
nvoRemCapSilv	Remaining Ag-Ion capacity	0 - 58.4 Ah	SNVT_count_f	51	11
nvoTaAgCurrent	Target Ag-Ion current	0 - 29.2 mA	SNVT_amp_mil	2	12
nvoPressInlet	Inlet pressure PS4 ¹⁾	0 - 12.0 bar 0 - 174.0 psi	SNVT_count_f	51	13
nvoPressNozzle	Nozzle pressure PS5 ¹⁾	0 - 12.0 bar 0 - 174.0 psi	SNVT_count_f	51	14
nvoActPermTemp	Water temperature ¹⁾	°C or °F	SNVT_count_f	51	15
nvoActPermCond	Conductivity	µS/cm	SNVT_count_f	51	16
nvoPumpCurrent	Pump current	0 - 5.0 A	SNVT_amp	1	17
nvoAgCurrent	Ag-Ion current	mA	SNVT_amp_mil	2	18
nvoSetPointHum nviSetPointHum	Humidity setpoint	0 - 95 %	SNVT_lev_percent	81	19 20

Variable Name	Description	Range	SNVT	#SNVT	Index
nvoPropBand nviPropBand	Proportional band	6 - 65 %	SNVT_lev_percent	81	21 22
nvoIntTime nviIntTime	Integral time	1 - 60 min	SNVT_time_min	123	23 24
nvoCapLimit nviCapLimit	Manual capacity	20 - 100 %	SNVT_lev_percent	81	25 26
nvoRemoteFlush nviRemoteFlush	Remote flush	Read: 0 = Off 2 = Flushing active Write: 0 = Stop flushing 1 = Start flushing	SNVT_count	8	27 28
nvoCerWashOver nviCerWashOver	Ceramic wash over	Read: 0 = Off 2 = Ceramic wash over active Write: 0 = Stop ceramic wash over 1 = Start ceramic wash over	SNVT_count	8	29 30
nvoRemRHorDem nviRemRHorDem	Actual humidity or demand via LonWorks	0 - 100 %	SNVT_lev_percent	81	31 32

¹⁾ According to the settings <Imperial> or <Metric> in the DL controller software.

²⁾ See Error code description in the malfunction list in the DL operation manual.

Variable Name	Description	Range	SNVT	#SNVT	Index
nvoExtSChSta	Safety loop	0 = Open 1 = Closed (ok)	SNVT_switch	95	33
nvoValveY1	Y1 inlet valve	0 = Closed 1 = Open	SNVT_switch	95	34
nvoValveY2	Y2 valve	0 1	SNVT_switch	95	35
nvoValveY3	Y3 valve air cleaning	0 = Closed 1 = Open	SNVT_switch	95	36
nvoValveY4	Y4 valve external pipe flush	0 = Closed 1 = Open	SNVT_switch	95	37
nvoStageY5	Y5 valve spray circuit	0 = Closed 1 = Open	SNVT_switch	95	38
nvoStageY6	Y6 valve spray circuit	0 = Closed 1 = Open	SNVT_switch	95	39
nvoStageY7	Y7 valve spray circuit	0 = Closed 1 = Open	SNVT_switch	95	40
nvoStageY8	Y8 valve spray circuit	0 = Closed 1 = Open	SNVT_switch	95	41
nvoStageY9	Y9 valve spray circuit	0 = Closed 1 = Open	SNVT_switch	95	42
nvoDrainValY10	Y10 valve drain (NO)	0 = Open 1 = Closed	SNVT_switch	95	43
nvoValveY11	Y11 auxiliary outlet valve	0 = Open 1 = Closed	SNVT_switch	95	44
nvoPump	FC enable	0 = Disable 1 = Enable	SNVT_switch	95	45
nvoConnection	Node status	0 = Node offline 1 = Node online	SNVT_switch	95	46

3.4.3 ME - BACnet (Integrated Controller software version 5.9.x.x and 5.10.x.x)

Object Name	Description	Range	Object-Type	Object-ID	Read (R) Write (W)
Virtual_BCU_ME	Humidifier ME	—	DEV	410 (see chapter 3.3.2)	—
MI_HumStatus	Operating status	1 = Initializing 2 = Diagnostic 3 = Stopped 4 = Humidifying 5 = Cooling 6 = Holding 7 = Draining 8 = Refreshing 9 = Filling 10= Standby 11= Diluting 12= Drain Assisting 13= Bleeding 14= Ramping Up 15= Switched Off 16= Remote Off 17= Purging 18= Drain Check	MI	01	R
MI_ServStatus	Maintenance and malfunctions status	1 = Service Info 2 = Warning 3 = Service 4 = Refill Liquid 5 = Replace Pure-Flow Ag+ 6 = Replace UV Bulb 7 = Matrix Wash Over 8 = Out of Commissioning 9 = Activation Code 10= Fault	MI	02	R
AI_ErrorCode	Error code ²⁾	0 = no Error	AI	01	R
AI_OperatHours	Operating hours	0 - 1'200'000 h	AI	02	R
AI_NextSySvc	Next service	0 - 10000 h	AI	03	R
AI_NextUVSvc	Next UV bulb exchange	0 - 450 d	AI	04	R
AI_NextAgSvc	Next PureFlo Ag+ exchange	0 - 350 d	AI	05	R
AI_RHorDemand	Actual humidity or demand	0 - 100 %	AI	06	R
AI_Temp	Actual air temperature ¹⁾	°C or °F	AI	07	R
AI_UVCurrA	UV current	0 - 4.0 A	AI	08	R
AI_Stage1Cap	Water capacity stage 1 ¹⁾	5.0 - 200.0 kg/h 11.0 - 440.9 lb/h	AI	09	R
AI_Stage2Cap	Water capacity stage 2 ¹⁾	5.0 - 200.0 kg/h 11.0 - 440.9 lb/h	AI	10	R
AI_Stage3Cap	Water capacity stage 3 ¹⁾	5.0 - 200.0 kg/h 11.0 - 440.9 lb/h	AI	11	R
AI_Stage4Cap	Water capacity stage 4 ¹⁾	5.0 - 200.0 kg/h 11.0 - 440.9 lb/h	AI	12	R
AI_Stage5Cap	Water capacity stage 5 ¹⁾	5.0 - 200.0 kg/h 11.0 - 440.9 lb/h	AI	13	R
AI_Stage6Cap	Water capacity stage 6 ¹⁾	5.0 - 200.0 kg/h 11.0 - 440.9 lb/h	AI	14	R
AI_Stage7Cap	Water capacity stage 7 ¹⁾	5.0 - 200.0 kg/h 11.0 - 440.9 lb/h	AI	15	R
AI_SpeedPump1	Demand pump 1	0 - 100 %	AI	16	R
AI_SpeedPump2	Demand pump 2	0 - 100 %	AI	17	R

Object Name	Description	Range	Object-Type	Object-ID	Read (R) Write (W)
AI_SpeedPump3	Demand pump 3	0 - 100 %	AI	18	R
AI_SpeedPump4	Demand pump 4	0 - 100 %	AI	19	R
AI_SpeedPump5	Demand pump 5	0 - 100 %	AI	20	R
AI_SpeedPump6	Demand pump 6	0 - 100 %	AI	21	R
AI_SpeedPump7	Demand pump 7	0 - 100 %	AI	22	R
AI_ConductLp	Conductivity	µS	AI	23	R
AI_WtrTmp	Actual water temperature ¹⁾	°C or °F	AI	24	R
AI_AirTmp	Actual air temperature ¹⁾	°C or °F	AI	25	R
AI_NumStgAct	Number of running stages	0 - 7 stages	AI	26	R
AI_Level	Water level in tub	0 - 8	AI	27	R

¹⁾ According to the settings <Imperial> or <Metric> in the ME controller software.

²⁾ See Error code description in the malfunction list in the ME operation manual.

Object Name	Description	Range	Object-Type	Object-ID	Read (R) Write (W)
AV_SetPointHum	Humidity setpoint	0 - 95 %	AV	01	R/W
AV_PropBandH	Proportional band humidity control	6 - 65 %	AV	02	R/W
AV_IntTimeH	Integral time humidity control	1 - 60 min	AV	03	R/W
AV_SetPointTmp	Temperature setpoint ¹⁾	5 - 40 °C 41 - 104 °F	AV	04	R/W
AV_PropBandT	Proportional band temperature control ¹⁾	1 - 50 °C 34 - 122 °F	AV	05	R/W
AV_IntTimeT	Integral time temperatur control	1 - 60 min	AV	06	R/W
AV_WashAct	Matrix wash over / Tank draining	Read: 0 = Off 1 = Initialisierung 2 = Process active 3 = Process completed Write: 0 = Stop active process 1 = Start matrix wash over 2 = Start tank draining	AV	07	R/W
AO_RemRHorDem	Actual humidity or demand via BACnet	0 - 100% Relinquish Default = 0	AO	01	R/W
AO_RemTemp	Actual temperature via BACnet ¹⁾	-25 - 100 °C -13 - 212 °F Relinquish Default = 0	AO	02	R/W

¹⁾ According to the settings <Imperial> or <Metric> in the ME controller software.

Object Name	Description	Range	Object-Type	Object-ID	Read(R) Write (W)
BI_ExtSchLSta	Safety loop	0 = Open 1 = Closed (ok)	BI	01	R
BI_DosLvl	Dosing pump level	0 = Empty 1 = Ok	BI	02	R
BI_Leak	Leakage sensor	0 = Leakage 1 = Ok	BI	03	R
BI_DrainValLp	Drain valve	0 = Open 1 = Closed	BI	04	R
BI_FillValLp	Inlet valve	0 = Closed 1 = Open	BI	05	R
BI_DrainPump	Drain pump	0 = Off 1 = On	BI	06	R
BI_Pump1Err	Fault pump 1	0 = Fault 1 = Ok	BI	07	R
BI_Pump2Err	Fault pump 2	0 = Fault 1 = Ok	BI	08	R
BI_Pump3Err	Fault pump 3	0 = Fault 1 = Ok	BI	09	R
BI_Pump4Err	Fault pump 4	0 = Fault 1 = Ok	BI	10	R
BI_Pump5Err	Fault pump 5	0 = Fault 1 = Ok	BI	11	R
BI_Pump6Err	Fault pump 6	0 = Fault 1 = Ok	BI	12	R
BI_Pump7Err	Fault pump 7	0 = Fault 1 = Ok	BI	13	R
BI_InletErr	Fault water inlet	0 = Fault 1 = Ok	BI	14	R
BI_TempErr	Fault water temperature	0 = Fault 1 = Ok	BI	15	R
BI_OutletErr	Fault water outlet	0 = Fault 1 = Ok	BI	16	R
BI_LevSenErr	Fault level sensor	0 = Fault 1 = Ok	BI	17	R
BI_CondErr	Fault water conductivity	0 = Fault 1 = Ok	BI	18	R
BI_Connection	Node status	0 = Node offline 1 = Node online	BI	19	R
BV_Reset	Remote reset	0 = Off 1 = On	BV	01	R/W

3.4.4 ME- LonWorks (Integrated Controller software version 5.9.x.x and 5.10.x.x)

Variable Name	Description	Range	SNVT	#SNVT	Index
nviRequest	Requesting the status		SNVT_obj_request	92	0
nvoStatus	Current status		SNVT_obj_status	93	1
nvoHumStatus	Operating status	0 = Initializing 1 = Diagnostic 2 = Stopped 3 = Humidifying 4 = Cooling 5 = Holding 6 = Draining 7 = Refreshing 8 = Filling 9 = Standby 10 = Diluting 11 = Drain Assisting 12 = Bleeding 13 = Ramping Up 14 = Switched Off 15 = Remote Off 16 = Purging 17 = Drain Check	SNVT_count	8	2
nvoServStatus	Maintenance and malfunctions status	0 = Service Info 1 = Warning 2 = Service 3 = Refill Liquid 4 = Replace PureFlow Ag+ 5 = Replace UV Bulb 6 = Matrix Wash Over 7 = Out of Commissioning 8 = Activation Code 9 = Fault	SNVT_count	8	3
nvoErrorCode	Error code ²⁾	0 = no Error	SNVT_count	8	4
nvoOperatHours	Operating hours	0 - 65535 h	SNVT_time_hour	124	5
nvoNextSySvc	Next service	0 - 10000 h	SNVT_time_hour	124	6
nvoNextUVSvc	Next UV bulb exchange	0 - 450 d	SNVT_count	8	7
nvoNextAgSvc	Next PureFlo Ag+ exchange	0 - 350 d	SNVT_count	8	8
nvoRHorDemand	Actual humidity or demand	0 - 100 %	SNVT_lev_percent	81	9
nvoTemp	Actual air temperature ¹⁾	°C or °F	SNVT_count_f	51	10
nvoUVCurrA	UV current	0 - 4.0 A	SNVT_amp	1	11
nvoStage1Cap	Water capacity stage 1 ¹⁾	5.0 - 200.0 kg/h 11.0 - 440.9 lb/h	SNVT_count_f	51	12
nvoStage2Cap	Water capacity stage 2 ¹⁾	5.0 - 200.0 kg/h 11.0 - 440.9 lb/h	SNVT_count_f	51	13
nvoStage3Cap	Water capacity stage 3 ¹⁾	5.0 - 200.0 kg/h 11.0 - 440.9 lb/h	SNVT_count_f	51	14
nvoStage4Cap	Water capacity stage 4 ¹⁾	5.0 - 200.0 kg/h 11.0 - 440.9 lb/h	SNVT_count_f	51	15
nvoStage5Cap	Water capacity stage 5 ¹⁾	5.0 - 200.0 kg/h 11.0 - 440.9 lb/h	SNVT_count_f	51	16
nvoStage6Cap	Water capacity stage 6 ¹⁾	5.0 - 200.0 kg/h 11.0 - 440.9 lb/h	SNVT_count_f	51	17
nvoStage7Cap	Water capacity stage 7 ¹⁾	5.0 - 200.0 kg/h 11.0 - 440.9 lb/h	SNVT_count_f	51	18
nvoSpeedPump1	Demand pump 1	0 - 100 %	SNVT_count	8	19
nvoSpeedPump2	Demand pump 2	0 - 100 %	SNVT_count	8	20

Variable Name	Description	Range	SNVT	#SNVT	Index
nvoSpeedPump3	Demand pump 3	0 - 100 %	SNVT_count	8	21
nvoSpeedPump4	Demand pump 4	0 - 100 %	SNVT_count	8	22
nvoSpeedPump5	Demand pump 5	0 - 100 %	SNVT_count	8	23
nvoSpeedPump6	Demand pump 6	0 - 100 %	SNVT_count	8	24
nvoSpeedPump7	Demand pump 7	0 - 100 %	SNVT_count	8	25
nvoConductLp	Conductivity	µS	SNVT_count_f	51	26
nvoWtrTmp	Actual water temperature ¹⁾	°C or °F	SNVT_count_f	51	27
nvoAirTmp	Actual air temperature ¹⁾	°C or °F	SNVT_count_f	51	28
nvoNumStgAct	Number of running stages	0 - 7 stages	SNVT_count	8	29
nvoLevel	Water level in tub	0 - 8	SNVT_count	8	30

¹⁾ According to the settings <Imperial> or <Metric> in the ME controller software.

²⁾ See Error code description in the malfunction list in the ME operation manual.

Variable Name	Description	Range	SNVT	#SNVT	Index
nvoSetPointHum nviSetPointHum	Humidity setpoint	0 - 95 %	SNVT_lev_percent	81	31 32
nvoPropBandH nviPropBandH	Proportional band humidity control	6 - 65 %	SNVT_lev_percent	81	33 34
nvoIntTimeH nviIntTimeH	Integral time humidity control	1 - 60 min	SNVT_time_min	123	35 36
nvoSetPointTmp nviSetPointTmp	Temperature setpoint ¹⁾	5 - 40 °C 41 - 104 °F	SNVT_count_f	51	37 38
nvoPropBandT nviPropBandT	Proportional band temperature control ¹⁾	1 - 50 °C 34 - 122 °F	SNVT_count_f	51	39 40
nvoIntTimeT nviIntTimeT	Integral time temperatur control	1 - 60 min	SNVT_time_min	123	41 42
nvoWashAct nviWashAct	Matrix wash over / Tank draining	Read: 0 = Off 1 = Initialisierung 2 = Process active 3 = Process completed Write: 0 = Stop active process 1 = Start matrix wash over 2 = Start tank draining	SNVT_count	8	43 44
nvoRemRHorDem nviRemRHorDem	Actual humidity or demand via Lonworks	0 - 100 %	SNVT_lev_percent	81	45 46
nvoRemTemp nviRemTemp	Actual temperature via Lonworks ¹⁾	0 - 100 °C 0 - 212 °F	SNVT_count_f	51	47 48

¹⁾ According to the settings <Imperial> or <Metric> in the ME controller software.

Variable Name	Description	Range	SNVT	#SNVT	Index
nvoExtSChLSta	Safety loop	0 = Open 1 = Closed (ok)	SNVT_switch	95	49
nvoDosLvl	Dosing pump level	0 = Empty 1 = Ok	SNVT_switch	95	50
nvoLeak	Leakage sensor	0 = Leakage 1 = Ok	SNVT_switch	95	51
nvoDrainValLp	Drain valve	0 = Open 1 = Closed	SNVT_switch	95	52
nvoFillValLp	Inlet valve	0 = Closed 1 = Open	SNVT_switch	95	53
nvoDrainPump	Drain pump	0 = Off 1 = On	SNVT_switch	95	54
nvoPump1Err	Fault pump 1	0 = Fault 1 = Ok	SNVT_switch	95	55
nvoPump2Err	Fault pump 2	0 = Fault 1 = Ok	SNVT_switch	95	56
nvoPump3Err	Fault pump 3	0 = Fault 1 = Ok	SNVT_switch	95	57
nvoPump4Err	Fault pump 4	0 = Fault 1 = Ok	SNVT_switch	95	58
nvoPump5Err	Fault pump 5	0 = Fault 1 = Ok	SNVT_switch	95	59
nvoPump6Err	Fault pump 6	0 = Fault 1 = Ok	SNVT_switch	95	60
nvoPump7Err	Fault pump 7	0 = Fault 1 = Ok	SNVT_switch	95	61
nvoInletErr	Fault water inlet	0 = Fault 1 = Ok	SNVT_switch	95	62
nvoTempErr	Fault water temperature	0 = Fault 1 = Ok	SNVT_switch	95	63
nvoOutletErr	Fault water outlet	0 = Fault 1 = Ok	SNVT_switch	95	64
nvoLevSenErr	Fault level sensor	0 = Fault 1 = Ok	SNVT_switch	95	65
nvoCondErr	Fault water conductivity	0 = Fault 1 = Ok	SNVT_switch	95	66
nvoConnection	Node status	0 = Node offline 1 = Node online	SNVT_switch	95	67
nvoReset	Remote reset	0 = Off	SNVT_switch	95	68
nviReset		1 = On			69

3.4.5 RS - BACnet (Integrated Controller software version 5.9.x.x)

Object Name	Description	Range	Object-Type	Object-ID	Read (R) Write (W)
Virtual_BCU_RS	Humidifier RS	—	DEV	710 (see chapter 3.3.2)	—
MI_UnitStatusA	Operating status unit A	1 = Initializing 2 = Diagnostic 3 = Stopped 4 = Break 5 = Level test 6 = Standby 7 = Humidifying 8 = Filling 9 = Idle 10= Draining 11= Remote off 12= Keep Warm	MI	01	R
MI_UnitStatusB	Operating status unit B	1 = Initializing 2 = Diagnostic 3 = Stopped 4 = Break 5 = Level test 6 = Standby 7 = Humidifying 8 = Filling 9 = Idle 10= Draining 11= Remote off 12= Keep Warm	MI	02	R
MI_ServStatusA	Maintenance and malfunctions status unit A	1 = Service Info 2 = Warning 3 = RO Service 4 = Extended Maint. 5 = Small Maint. 6 = Activation Code 7 = Fault	MI	03	R
MI_ServStatusB	Maintenance and malfunctions status unit B	1 = Service Info 2 = Warning 3 = RO Service 4 = Extended Maint. 5 = Small Maint. 6 = Activation Code 7 = Fault	MI	04	R
MI_HumType	Device type	1 = RS 2 = RS+ RO 3 = RO	MI	05	R
MI_NomVoltage	Nominal voltage	1 = 200 V 2 = 208 V 3 = 230 V 4 = 240 V 5 = 400 V 6 = 415 V 7 = 440 V 8 = 460 V 9 = 480 V 10= 500 V 11= 550 V 12= 600 V 13= 380 V	MI	06	R
MI_LevelA	Water level unit A	1 = no level 2 = low 3 = low-mid 4 = mid 5 = mid-high 6 = high	MI	07	R

Object Name	Description	Range	Object-Type	Object-ID	Read (R) Write (W)
MI_LevelB	Water level unit B	1 = no level 2 = low 3 = low-mid 4 = mid 5 = mid-high 6 = high	MI	08	R
AI_ErrorCode	Error code ²⁾	0 = No Error	AI	01	R
AI_OperatHours	Operating hours	0 - 1'200'000 h	AI	02	R
AI_HoursToServA	Next service unit A	0 - 6000 h	AI	03	R
AI_HoursToServB	Next service unit B		AI	04	R
AI_SystemDemand	System demand	0 - 100 %	AI	05	R
AI_InputA1	Input signal channel 1 unit A	0 - 100 %	AI	06	R
AI_InputA2	Limiter signal channel 2 unit A	0 - 100 %	AI	07	R
AI_MaxHumOut	Max. capacity ¹⁾	5 - 160 kg/h 10 - 360 lb/hr	AI	08	R
AI_CylMaxCapA	Max. capacity unit A ¹⁾	5 - 40 kg/h 10 - 90 lb/hr	AI	09	R
AI_CylMaxCapB	Max. capacity unit B ¹⁾	5 - 40 kg/h 10 - 90 lb/hr	AI	10	R
AI_ActCapHum	Actual capacity ¹⁾	0 - 160 kg/h 0 - 360 lb/hr	AI	11	R
AI_CylActCapA	Actual capacity unit A ¹⁾	0 - 40 kg/h 0 - 90 lb/hr	AI	12	R
AI_CylActCapB	Actual capacity unit B ¹⁾	0 - 40 kg/h 0 - 90 lb/hr	AI	13	R

¹⁾ According to the settings <Imperial> or <Metric> in the RS controller software.

²⁾ See Error code description in the malfunction list in the RS operation manual.

Object Name	Description	Range	Object-Type	Object-ID	Read (R) Write (W)
AV_SetPointA1	Setpoint channel 1 unit A	0 - 95 %	AV	01	R/W
AV_SetPointA2	Setpoint channel 2 limiter unit A	10 - 95 %	AV	02	R/W
AV_PropBandA1	P-Band unit A (proportional band)	6 - 65 %	AV	03	R/W
AV_PropBandA2	P-Band limiter unit A (Proportional band)	6 - 65 %	AV	04	R/W
AV_IntTimeA1	Integral time channel 1 unit A	1 - 60 min	AV	05	R/W
AV_DampTimeA2	Damp time channel 2 unit A	0 - 60 s	AV	06	R/W
AV_CapLimitA	Manual capacity unit A	20 - 100 %	AV	07	R/W

Object Name	Description	Range	Object-Type	Object-ID	Read (R) Write (W)
AV_RemoteDrain	Remote drain	Read: 0= Off 1=Init 2=busy 3=done Write 0=Off 1= RS drain cylinder A 2= RS drain cylinder B 3= RS drain cyl. A+B 4 = RO flush 5 = RO fresh water automation	AV	08	R/W
AO_RemRHorDemA1	Actual humidity or demand via BACnet unit A	0 - 100 % Relinquish Default = 0	AO	01	R/W
AO_RemRHorDemA2	Actual humidity or limiter via BACnet unit A	0 - 100 % Relinquish Default = 0	AO	02	R/W

Object Name	Description	Range	Object-Type	Object-ID	Read (R) Write (W)
BI_BlowerPackA	Blower ready unit A	0 = Off 1 = On (ready)	BI	01	R
BI_BlowerPackB	Blower ready unit B	0 = Off 1 = On (ready)	BI	02	R
BI_ExtSChStaA	External safety loop unit A	0 = Open 1 = Closed (ok)	BI	03	R
BI_ExtSChStaB	External safety loop unit B	0 = Open 1 = Closed (ok)	BI	04	R
BI_IntSChStaA	Internal safety loop unit A	0 = Open 1 = Closed (ok)	BI	05	R
BI_IntSChStaB	Internal safety loop unit B	0 = Open 1 = Closed (ok)	BI	06	R
BI_HeatVoltageA	Heating voltage unit A	0 = Off 1 = On	BI	07	R
BI_HeatVoltageB	Heating voltage unit B	0 = Off 1 = On	BI	08	R
BI_LevelSafetyA	Internal safety loop unit A (security level)	0 = Off 1 = On (ok)	BI	09	R
BI_LevelSafetyB	Internal safety loop unit B (security level)	0 = Off 1 = On (ok)	BI	10	R
BI_LeakA	Leakage sensor unit A	0 = Off (Leak) 1 = On	BI	11	R
BI_LeakB	Leakage sensor unit B	0 = Off (Leak) 1 = On	BI	12	R
BI_MainContactA	Contactor unit A	0 = Off 1 = On	BI	13	R
BI_MainContactB	Contactor unit B	0 = Off 1 = On	BI	14	R
BI_PumpA	Pump unit A	0 = Off 1 = On	BI	15	R
BI_PumpB	Pump unit B	0 = Off 1 = On	BI	16	R

Object Name	Description	Range	Object-Type	Object-ID	Read (R) Write (W)
BI_InletA1	Inlet valve 1 unit A	0 = Closed 1 = Open	BI	17	R
BI_InletB1	Inlet valve 1 unit B	0 = Closed 1 = Open	BI	18	R
BI_InletA2	Inlet valve 2 unit A	0 = Closed 1 = Open	BI	19	R
BI_InletB2	Inlet valve 2 unit B	0 = Closed 1 = Open	BI	20	R
BI_DrainA1	Drain cool valve unit A	0 = Closed 1 = Open	BI	21	R
BI_DrainB1	Drain cool valve unit B	0 = Closed 1 = Open	BI	22	R
BI_DrainA2	Complete drain valve unit A	0 = Closed 1 = Open	BI	23	R
BI_DrainB2	Complete drain valve unit B	0 = Closed 1 = Open	BI	24	R
BI_FanA	External fan unit A	0 = Off 1 = On	BI	25	R
BI_FanB	External fan unit B	0 = Off 1 = On	BI	26	R
BI_FlushValveA	Hygiene flush unit A	0 = Closed 1 = Open	BI	27	R
BI_FlushValveB	Hygiene flush unit B	0 = Closed 1 = Open	BI	28	R
BI_Connection	Node status	0 = Node offline 1 = Node online	BI	29	R

3.4.6 RS - LonWorks (Integrated Controller software version 5.9.x.x)

Variable Name	Description	Range	SNVT	#SNVT	Index
nviRequest	Requesting the status		SNVT_obj_request	92	0
nvoStatus	Current status		SNVT_obj_status	93	1
nvoUnitStatusA	Operating status unit A	0 = Initializing 1 = Diagnostic 2 = Stopped 3 = Break 4 = Level test 5 = Standby 6 = Humidifying 7 = Filling 8 = Idle 9 = Draining 10 = Remote off 11 = Keep Warm	SNVT_count	8	2
nvoUnitStatusB	Operating status unit B	0 = Initializing 1 = Diagnostic 2 = Stopped 3 = Break 4 = Level test 5 = Standby 6 = Humidifying 7 = Filling 8 = Idle 9 = Draining 10 = Remote off 11 = Keep Warm	SNVT_count	8	3
nvoServStatusA	Maintenance and malfunctions status unit A	0 = Service Info 1 = Warning 2 = RO Service 3 = Extended Maint. 4 = Small Maint. 5 = Activation Code 6 = Fault	SNVT_count	8	4
nvoServStatusB	Maintenance and malfunctions status unit B	0 = Service Info 1 = Warning 2 = RO Service 3 = Extended Maint. 4 = Small Maint. 5 = Activation Code 6 = Fault	SNVT_count	8	5
nvoHumType	Device type	0 = RS 1 = RS+ RO 2 = RO	SNVT_count	8	6
nvoNomVoltage	Nominal voltage	0 = 200 V 1 = 208 V 2 = 230 V 3 = 240 V 4 = 400 V 5 = 415 V 6 = 440 V 7 = 460 V 8 = 480 V 9 = 500 V 10 = 550 V 11 = 600 V 12 = 380 V	SNVT_volt	44	7
nvoLevelA	Water level unit A	0 = no level 1 = low 2 = low-mid 3 = mid 4 = mid-high 5 = high	SNVT_count	8	8

Variable Name	Description	Range	SNVT	#SNVT	Index
nvoLevelB	Water level unit B	0 = no level 1 = low 2 = low-mid 3 = mid 4 = mid-high 5 = high	SNVT_count	8	9
nvoErrorCode	Error code ²⁾	0 = No Error	SNVT_count	8	10
nvoOperatHours	Operating hours	0 - 65535 h	SNVT_time_hour	124	11
nvoHoursToServA	Next service unit A	0 - 6000 h	SNVT_time_hour	124	12
nvoHoursToServB	Next service unit B		SNVT_time_hour	124	13
nvoSystemDemand	System demand	0 - 100 %	SNVT_lev_percent	81	14
nvoInputA1	Input signal channel 1 unit A	0 - 100 %	SNVT_lev_percent	81	15
nvoInputA2	Limiter signal channel 2 unit A	0 - 100 %	SNVT_lev_percent	81	16
nvoMaxHumOut	Max. capacity ¹⁾	5 - 160 kg/h 10 - 360 lb/hr	SNVT_count_f	51	17
nvoCylMaxCapA	Max. capacity unit A ¹⁾	5 - 40 kg/h 10 - 90 lb/hr	SNVT_count_f	51	18
nvoCylMaxCapB	Max. capacity unit B ¹⁾	5 - 40 kg/h 10 - 90 lb/hr	SNVT_count_f	51	19
nvoActCapHum	Actual capacity ¹⁾	0 - 160 kg/h 0 - 360 lb/hr	SNVT_count_f	51	20
nvoCylActCapA	Actual capacity unit A ¹⁾	0 - 40 kg/h 0 - 90 lb/hr	SNVT_count_f	51	21
nvoCylActCapB	Actual capacity unit B ¹⁾	0 - 40 kg/h 0 - 90 lb/hr	SNVT_count_f	51	22

¹⁾ According to the settings <Imperial> or <Metric> in the RS controller software.

²⁾ See Error code description in the malfunction list in the RS operation manual.

Variable Name	Description	Range	SNVT	#SNVT	Index
nvoSetPointA1 nviSetPointA1	Setpoint channel 1 unit A	0 - 95 %	SNVT_lev_percent	81	23 24
nvoSetPointA2 nviSetPointA2	Setpoint channel 2 limiter unit A	10 - 95 %	SNVT_lev_percent	81	25 26
nvoPropBandA1 nviPropBandA1	P-Band unit A (Proportional band)	6 - 65 %	SNVT_lev_percent	81	27 28
nvoPropBandA2 nviPropBandA2	P-Band limiter unit A (Proportional band)	6 - 65 %	SNVT_lev_percent	81	29 30
nvoIntTimeA1 nviIntTimeA1	Integral time channel 1 unit A	1 - 60 min	SNVT_time_min	123	31 32
nvoDampTimeA2 nviDampTimeA2	Damp time channel 2 unit A	0 - 60 s	SNVT_time_sec	107	33 34
nvoCapLimitA nviCapLimitA	Manual capacity unit A	20 - 100 %	SNVT_lev_percent	81	35 36

Variable Name	Description	Range	SNVT	#SNVT	Index
nvoRemoteDrain nviRemoteDrain	Remote Drain	Read: 0 = Off 1 = Init 2 = busy 3 = done Write 0 = Off 1 = RS drain cylinder A 2 = RS drain cylinder B 3 = RS drain cyl. A+B 4 = RO flush 5 = RO fresh water automation	SNVT_count	8	37 38
nvoRemRHorDemA1 nviRemRHorDemA1	Actual humidity or demand via Lonworks unit A	0 - 100 %	SNVT_lev_percent	81	39 40
nvoRemRHorDemA2 nviRemRHorDemA2	Actual humidity or limiter via Lonworks unit A	0 - 100 %	SNVT_lev_percent	81	41 42

Variable Name	Description	Range	SNVT	#SNVT	Index
nvoBlowerPackA	Blower ready unit A	0 = Off 1 = On (ready)	SNVT_switch	95	43
nvoBlowerPackB	Blower ready unit B	0 = Off 1 = On (ready)	SNVT_switch	95	44
nvoExtSChStaA	External safety loop unit A	0 = Open 1 = Closed (ok)	SNVT_switch	95	45
nvoExtSChStaB	External safety loop unit B	0 = Open 1 = Closed (ok)	SNVT_switch	95	46
nvoIntSChStaA	Internal safety loop unit A	0 = Open 1 = Closed (ok)	SNVT_switch	95	47
nvoIntSChStaB	Internal safety loop unit B	0 = Open 1 = Closed (ok)	SNVT_switch	95	48
nvoHeatVoltageA	Heating voltage unit A	0 = Off 1 = On	SNVT_switch	95	49
nvoHeatVoltageB	Heating voltage unit B	0 = Off 1 = On	SNVT_switch	95	50
nvoLevelSafetyA	Internal safety loop unit A (security level)	0 = Off 1 = On (ok)	SNVT_switch	95	51
nvoLevelSafetyB	Internal safety loop unit B (security level)	0 = Off 1 = On (ok)	SNVT_switch	95	52
nvoLeakA	Leakage sensor unit A	0 = Off (Leak) 1 = On	SNVT_switch	95	53
nvoLeakB	Leakage sensor unit B	0 = Off (Leak) 1 = On	SNVT_switch	95	54
nvoMainContactA	Contacteur unit A	0 = Off 1 = On	SNVT_switch	95	55
nvoMainContactB	Contacteur unit B	0 = Off 1 = On	SNVT_switch	95	56
nvoPumpA	Pump unit A	0 = Off 1 = On	SNVT_switch	95	57
nvoPumpB	Pump unit B	0 = Off 1 = On	SNVT_switch	95	58
nvoInletA1	Inlet valve 1 unit A	0 = Closed 1 = Open	SNVT_switch	95	59
nvoInletB1	Inlet valve 1 unit B	0 = Closed 1 = Open	SNVT_switch	95	60

Variable Name	Description	Range	SNVT	#SNVT	Index
nvoInletA2	Inlet valve 2 unit A	0 = Closed 1 = Open	SNVT_switch	95	61
nvoInletB2	Inlet valve 2 unit B	0 = Closed 1 = Open	SNVT_switch	95	62
nvoDrainA1	Drain cool valve unit A	0 = Closed 1 = Open	SNVT_switch	95	63
nvoDrainB1	Drain cool valve unit B	0 = Closed 1 = Open	SNVT_switch	95	64
nvoDrainA2	Complete drain valve unit A	0 = Closed 1 = Open	SNVT_switch	95	65
nvoDrainB2	Complete drain valve unit B	0 = Closed 1 = Open	SNVT_switch	95	66
nvoFanA	External fan unit A	0 = Off 1 = On	SNVT_switch	95	67
nvoFanB	External fan unit B	0 = Off 1 = On	SNVT_switch	95	68
nvoFlushValveA	Hygiene flush unit A	0 = Closed 1 = Open	SNVT_switch	95	69
nvoFlushValveB	Hygiene flush unit B	0 = Closed 1 = Open	SNVT_switch	95	70
nvoConnection	Node status	0 = Node offline 1 = Node online	SNVT_switch	95	71

3.5 Troubleshooting

3.5.1 Operating trouble list

Problem	Solutions
Cannot establish communication	<ul style="list-style-type: none"> – Check communication parameters (see chapter 3.3.1.3). – Check if the jumper J7 is removed. – Verify Hardware connections from network to BACnet or LonWorks gateway board (see chapter 3.2.2). – With BACnet IP: Check the IP address, subnet mask and default gateway. These parameters must be in the same range as the client (client = BACnet device, for example a building controller or workstation requesting data from the humidifier) Check if other network participants or firewalls are blocking BACnet messages. – With BACnet MS/TP Master: Check the MAC address. This should be in the range 0-127. The value in the Device Object property "Max Master" must be equal to or higher than the MAC address.. – With BACnet MS/TP Slave: MS/TP slave devices can not be detected automatically via the "Who-is" BACnet service and therefore have to be manually added to the network.
Condair Integrated Controller will not respond to set point/sensor values/demand values written over BACnet/LonWorks.	<ul style="list-style-type: none"> – Check that Condair Integrated Controller is configured to be controlled via automation system (see chapter 3.3.1.1). Note: If "Source" in the controller settings is set to "Analog" the Condair Integrated Controller will look for a control signal connected to the driver board only.
"MI_HumStatus" or "MI_UnitStatusA" show always "Initializing"	<p>Probably the communication between humidifier and gateway board is interrupted!</p> <ul style="list-style-type: none"> – Check the communication parameters (see chapter 3.3.1.3). – Ensure Jumper J7 is removed. – Ensure the gateway board is correctly inserted into the socket of the Integrated Controller.
"MI_UnitStatusB" shows always "Initializing"	<ul style="list-style-type: none"> – Check whether a B unit is present. Note: if only a A unit is operated the objects for the B unit are inactive. The text "Initializing" in "MI_UnitStatusB" is ok if no B unit exists.

Problem	Solutions
The device will not respond to control signal connected to the driver board.	<ul style="list-style-type: none"> – Check that "Signal Source" in the controller settings is configured for "Analog" control. Note: If the "Signal Source" is set to "Modbus", the Condair Integrated Controller will look for a control value sent by the gateway board.
Intermittent Communications.	<ul style="list-style-type: none"> – Check whether the wire type and run length meet the requirements of the corresponding network. – Look for wire runs in close proximity to equipment generating significant electrical noise (such as VFD's, medical equipment, X-ray machinery, servers, etc). – Check that wire shield is terminated at one end only. – Confirm correct polarity of conductors at each device. – Check BACnet/LonWorks addresses for conflicts with any device. Note: Each device on the network must have a unique address.
Invalid data	<ul style="list-style-type: none"> – Check BACnet/LonWorks addresses for conflicts with any device. Note: Each device on the network must have a unique address. – Check correct setting of Modbus parameter <Register sequence> according to chapter 3.3.1.3.
Error code "0" is shown though a fault is present on the Integrated Controller.	<ul style="list-style-type: none"> – Check software version of the Integrated Controller. Error code indication is not supported with software version 1.x.x.x.
Wrong values (e.g. temperature, pressure, mass flow) are shown.	<ul style="list-style-type: none"> – Check software version of the Integrated Controller. – Check the "Units" setting in the "General" menu.
Meaningless values outside the expected value range are displayed.	<ul style="list-style-type: none"> – Check the register order in the menu "Communication > Modbus Parameters". The register order must be set to "MSR First".
Humidifier type is not shown on top of the navigation tree of the FS-GUI.	<ul style="list-style-type: none"> – Probably the configuration has not been uploaded into the gateway board. Contact Condair Technical Services for additional support.
More variables or additional information is required from the Condair Integrated Controller.	<ul style="list-style-type: none"> – Contact Condair Technical Services for additional support.
The "Units" property is not defined for all BACnet objects, although the BACnet standard lists these units.	<ul style="list-style-type: none"> – BACnet objects that have units which differ depending on the setting "Metric" or "Imperial" are not fixed implemented. These include units such as temperature (°C or °F), pressure (bar or psi), mass flow (kg/h or lbs/hr).

3.5.2 LED functions



Abb. 8: BACnet IP / BACnet MS/TP LED's

LED	Description
HEART BEAT (amber)	The system indicator LED as indication that the operating system is running
ERROR (red)	The ERROR LED lights up on power up and goes off 15 seconds after power up. A steady red light will indicate there is a system error on the gateway board. The related "system error" is shown in the "User Messages / error screen" of the FS-GUI interface.
NODE OFF-LINE (amber)	The Node Offline LED lights up on power up and goes off 15 seconds after power up. If the Node Offline LED stays on solid, a Node Offline condition has occurred (no communication between Intergrated Controller and gateway board, check Modbus settings of the integrated Controller, and ensure that Jumper J7 has been removed).
RUN (green)	The RUN LED will start flashing 20 seconds after power indicating normal operation. The board will be able to access FS-GUI once this LED starts flashing.
TX	RS-485 indicator LED when a message is sent through the port.
RX	RS-485 indicator LED when a message is received by the port.

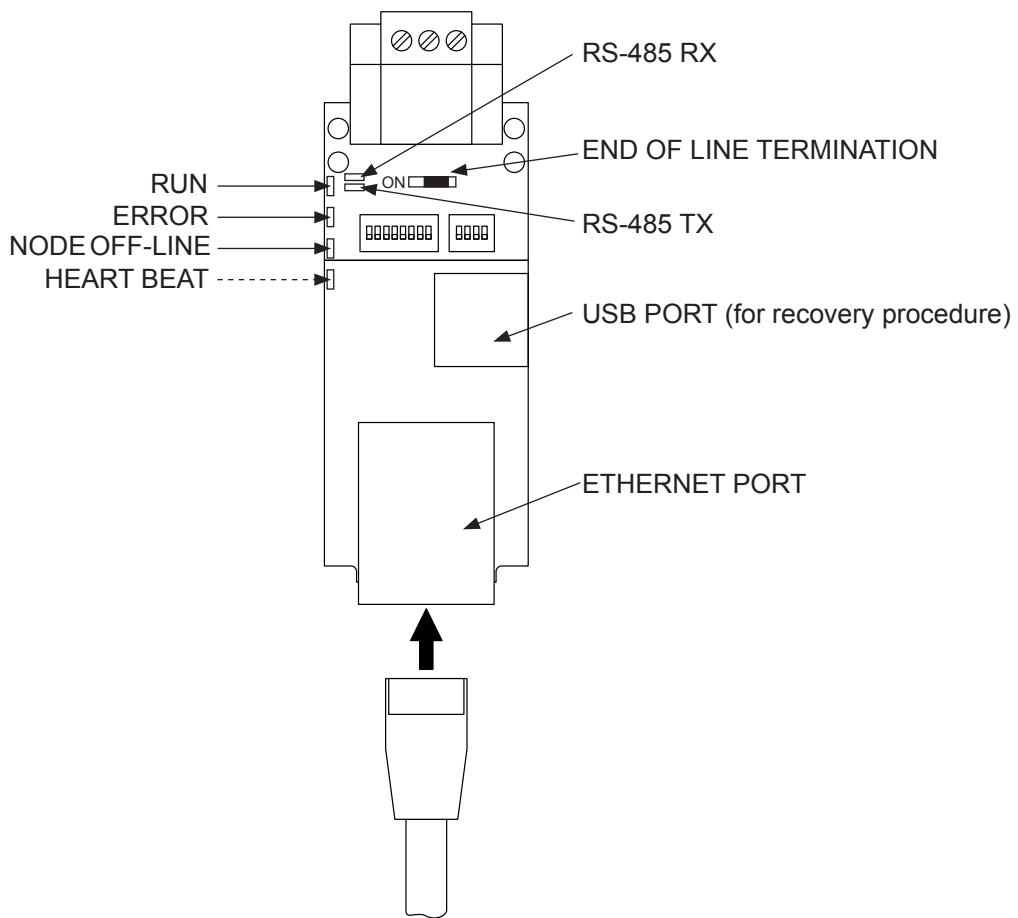

Abb. 9: LonWorks LED's

LED	Description
HEART BEAT (amber)	The system indicator LED as indication that the operating system is running
ERROR (red)	The ERROR LED lights up on power up and goes off 15 seconds after power up. A steady red light will indicate there is a system error on the gateway board. The related "system error" is shown in the "User Messages / error screen" of the FS-GUI interface.
NODE OFF-LINE (amber)	The Node Offline LED lights up on power up and goes off 15 seconds after power up. If the Node Offline LED stays on solid, a Node Offline condition has occurred (no communication between Intergrated Controller and gateway board or no network output variable (nvo) of the LonWorks gateway board has been binded to a network input variable of another Lon device). Check whether binding has been done, check the Modbus settings of the Inte-grated Controller, and ensure that Jumper J7 has been removed.
RUN (green)	The RUN LED will start flashing 20 seconds after power indicating normal operation. The board will be able to access FS-GUI once this LED starts flashing.
PWR (green)	This is the power light and should show steady green at all times when the board is powered.

LED	Description
LON-TX LED	On normal operation of the board, the TX LED will flash when a message is sent on the Lon port of the board.
LON-RX LED	On normal operation of the board, the RX LED will flash when a message is received on the Lon port of the board.
LON SERVICE LED (next to Lon port)	The LON SERVICE LED will flash if the board is configured for implicit addressing and not commissioned. LED will be off if the board is configured for implicit addressing and commissioned or if it is configured for explicit addressing.

4 Appendix

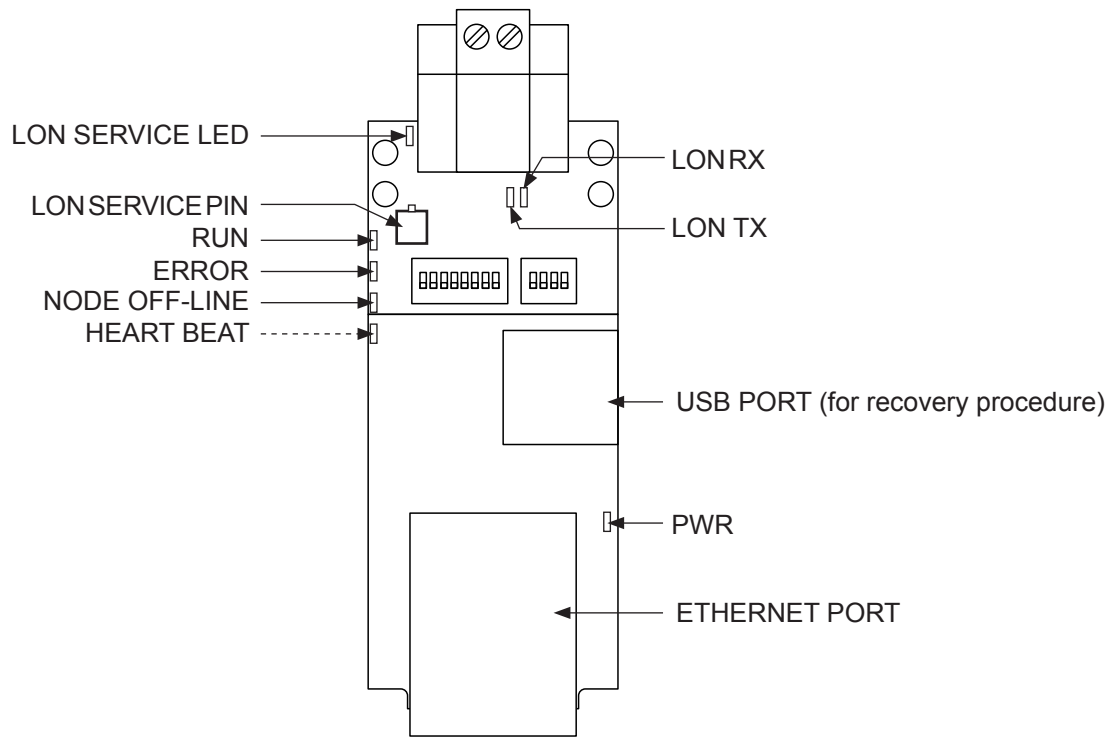
4.1 Object abbreviations

AI = Analog Input	Analog value, readable
AO = Analog Output	Analogue control signal, readable and writable (with priority)
AV = Analog Value	Analogue setting, readable and writable
BI = Binär Input	Binary state value, readable
BV = Binär Value	Binary value, readable and writable
MI = Multistate Input	Multistate status value, readable



Attention: Date:
 Company: Fax #:
 From: Page: of
 Subject:

FOR YOUR INFORMATION RESPONSE REQUESTED

MESSAGE:

Distributor / Agent P.O. Number: Sales Order Number:

Desired interface option:

- BACnet IP
- BACnet MS/TP
- LonWorks

Settings for BACnet only:

- Default Gateway Address/Name:
- BACnet Node ID (Device Instance):.....
- Network Number:
- Subnet Mask:
- Module IP Address:

Settings for BACnet MS/TP only:

- MAC Address BACnet MS/TP:.....
- Baud rate:.....

U.S.A.
 835 Commerce Park Drive
 Ogdensburg, New York 13669

CANADA
 2740 Fenton Road
 Ottawa, Ontario K1T 3T7

TEL: 1.866.667.8321
 FAX: 613.822.7964

EMAIL: na.info@condair.com
 WEBSITE: www.condair.com

Notes

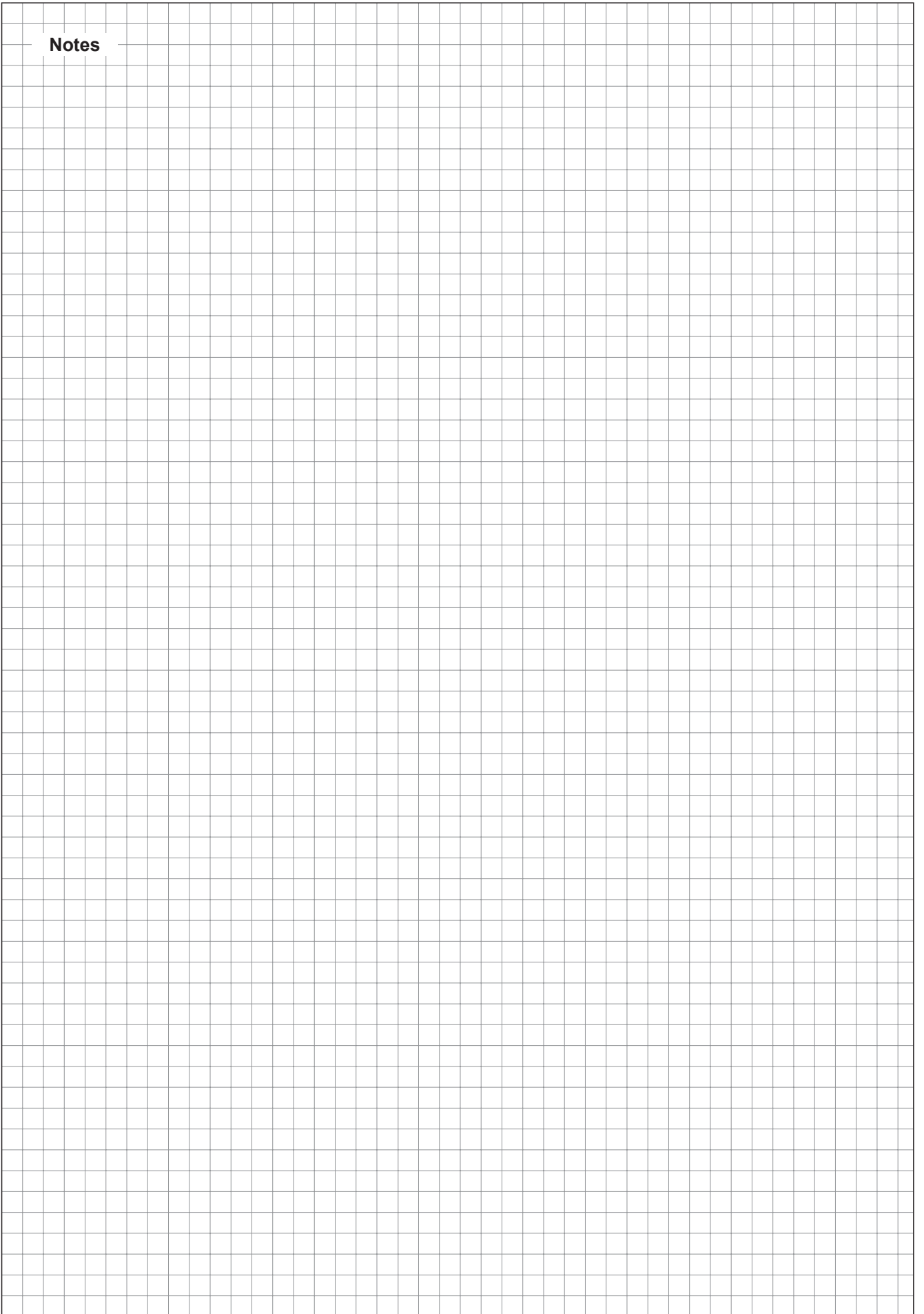

Notes

Warranty

Condair Inc. and/or Condair Ltd. (hereinafter collectively referred to as THE COMPANY), warrant for a period of two years after installation or 30 months from manufacturer's ship date, whichever date is earlier, that THE COMPANY's manufactured and assembled products, not otherwise expressly warranted (with the exception of the cylinder), are free from defects in material and workmanship. No warranty is made against corrosion, deterioration, or suitability of substituted materials used as a result of compliance with government regulations.

THE COMPANY's obligations and liabilities under this warranty are limited to furnishing replacement parts to the customer, F.O.B. THE COMPANY's factory, providing the defective part(s) is returned freight prepaid by the customer. Parts used for repairs are warranted for the balance of the term of the warranty on the original humidifier or 90 days, whichever is longer.

The warranties set forth herein are in lieu of all other warranties expressed or implied by law. No liability whatsoever shall be attached to THE COMPANY until said products have been paid for in full and then said liability shall be limited to the original purchase price for the product. Any further warranty must be in writing, signed by an officer of THE COMPANY.

THE COMPANY's limited warranty on accessories, not of the companies manufacture, such as controls, humidistats, pumps, etc. is limited to the warranty of the original equipment manufacturer from date of original shipment of humidifier.

THE COMPANY makes no warranty and assumes no liability unless the equipment is installed in strict accordance with a copy of the catalog and installation manual in effect at the date of purchase and by a contractor approved by THE COMPANY to install such equipment.

THE COMPANY makes no warranty and assumes no liability whatsoever for consequential damage or damage resulting directly from misapplication, incorrect sizing or lack of proper maintenance of the equipment.

THE COMPANY makes no warranty and assumes no liability whatsoever for damage resulting from freezing of the humidifier, supply lines, drain lines, or steam distribution systems.

THE COMPANY retains the right to change the design, specification and performance criteria of its products without notice or obligation.



U.S.A.
835 Commerce Park Drive
Ogdensburg, New York 13669

CANADA
2740 Fenton Road
Ottawa, Ontario K1T 3T7

TEL: 1.866.667.8321
FAX: 613.822.7964

EMAIL: na.info@condair.com
WEBSITE: www.condair.com

